

MarCal | Caliper

Calipers are some of the most important measuring instruments in production metrology due to their versatility and ease-of-use. Digital devices are simple to operate and easy to read. In addition, they enable fast and uncomplicated data acquisition.

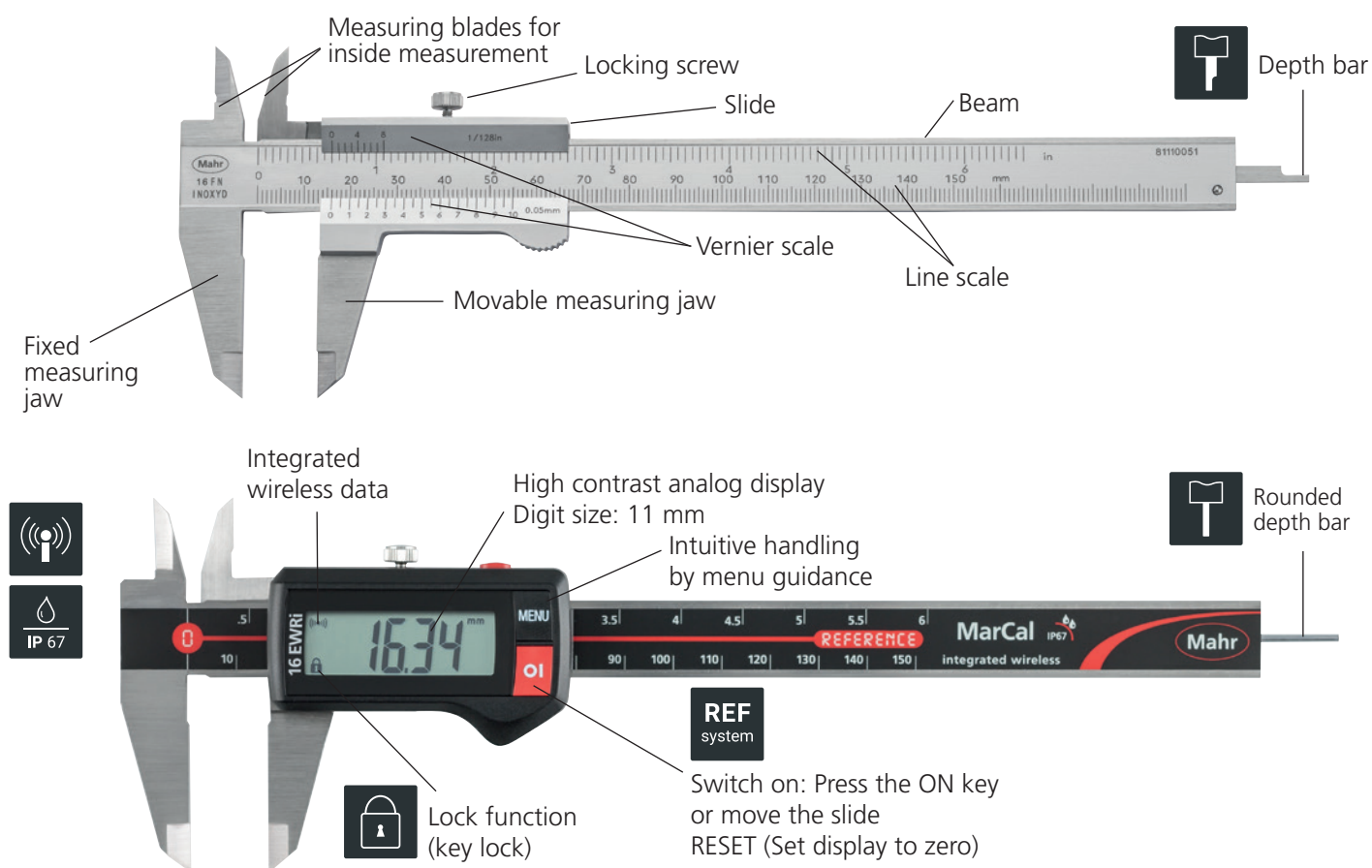

MarCal | Terms



MarCal | Types of measurement

16 series calipers (e.g. 16 EWRI, 16 U, 16 FN) can be used to conduct 4 different types of measurements:

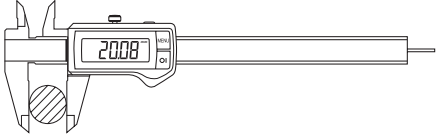
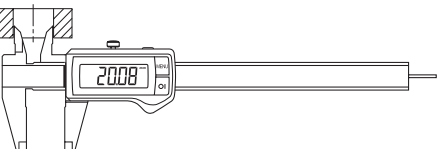
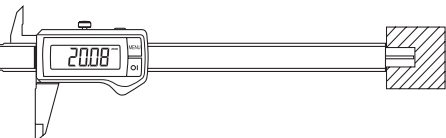
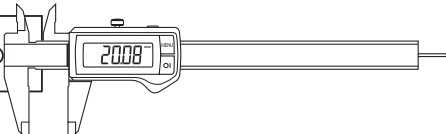
- a) Outside measurement 
- b) Inside measurement 
- c) Depth measurement 
- d) Step (Distance) measurement 

Error limits G according to DIN 862

Measuring length	Error limits G in μm		Resolution
	Scale interval and/or vernier interval		
mm	0.1 and 0.05	0.02	0.01
50	50	20	20
100			
200			
300	60	30	30
400			
500			
600	80	40	40
700			
800			
900	110	50	—
1000			
1200			
1400	140	60	—
1600			
1800			
2000	220		

MarCal - The innovative Reference System

REF
system

All Mahr digital calipers with this logo are equipped with the innovative Reference System. The zero position only has to be set once: after setting the zero position, the zero remains stored for all further measurements. Therefore, once the caliper is switched ON or the slide is moved the caliper is immediately ready for measurement. Once the caliper is initially set to zero, there is no need to reset to zero each time the caliper is turned on.

Conventional

- ① Switch ON ② Close the measuring jaws ③ Set to zero ④ Results of measurement

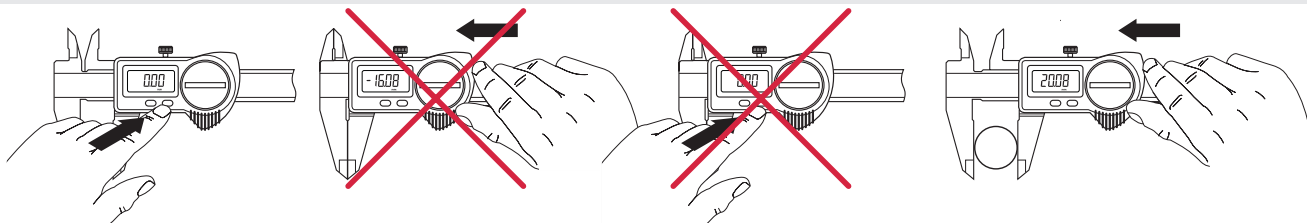

REF
system

- ① Switch ON ② Results of measurement

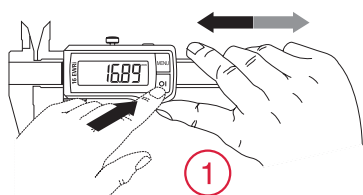

REF
system

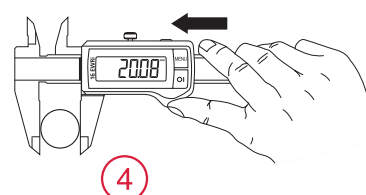

Press the ON key

or

move the slide

IP Protection classes

First digit is the degree of protection according to IEC 60529 – against particles, contaminants and dusts

Second digit is the degree of protection according to IEC 60529 (approximate) – against wet conditions (fluids)

- 0 Not protected
- 1 Particles > 50.0 mm
- 2 Particles > 12.5 mm
- 3 Particles > 2.5 mm
- 4 Particles > 1.0 mm
- 5 Dust protected
- 6 Dust tight

- 0 Not protected
- 1 Falling water drops - vertical
- 2 Falling water drops - tilted < 15°
- 3 Spray water < 60°
- 4 Water splashing from all directions
- 5 Water jets from all directions
- 6 Powerful water jets
- 7 Temporary immersion in water
- 8 Continuous immersion in water



Example
IP67 means that the product is dust tight and is protected against temporary immersion in water.

MarCal | The new Generation Waterproof Digital Calipers with the Reference System and Integrated Wireless

Security due to the Reference Lock function

- Zero-position is secured
- Operating error is not possible

The digital caliper MarCal 16 EWRi Reference is equipped with a LOCK function. With this key lock, the zero position is secured and operating error is avoided.



Battery service life is 3 years

The new Reference System is extremely energy efficient because of its standby mode feature; almost no power is required, thus extending the life of the battery up to 3 years*.

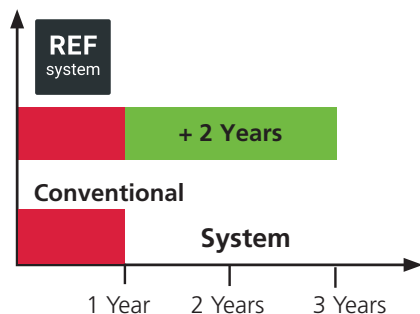

* When Integrated Wireless is deactivated

Superior quality of the guideways

Only MarCal calipers have lapped guideway surfaces, that guarantee an even and sensitive run of the slide. Additionally, the service life of the caliper increases, compared to a ground guideway due to the greater contact area on the guideway surface.



Surface of the guideway



MarConnect Integrated Wireless



Wireless data transmission for the price of a data cable.

Mahr's Integrated Wireless, users have a new Integrated Wireless data transmission system for the price of a data cable. Data acquisition with digital calipers is now even simpler: simply transmit your measured data directly into Microsoft Office Excel® or any Windows program with a keyboard code.

Secure data transmission



With Integrated Wireless, your data will be transferred to the digital indicator, which is confirmed with a message in the digital indicator's display. The message will show whether the sent data has been transferred correctly, and/or whether you are in the reception range of the i-Stick.



Ergonomic design

The handy non-slip thumb support of the MarCal 16 EWRi ensures, even in contaminated working conditions, trouble-free handling and therefore reliable measuring results.



The high-contrast display with 11 mm sized digits enables accurate, fatigue-free reading of the measurement results.

Excellent resistance against dust, coolant and lubricants



Due to the outstanding protection against dust and water, the digital caliper MarCal 16 EWRi Reference delivers precise and secure results, even in the most difficult workshop conditions. The finished plastic components have an outstanding chemical resistance.

Code Initials	IP	International Protection
First digit	6	Dust-tight
Second digit	7	Protected against temporary immersion in water



MarCal 16 EWRI

Digital Caliper



FUNCTIONS

- ON/OFF
- AUTO-ON / OFF
- HOLD (storage of measured values)
- RESET (set display to zero)
- PRESET (for entering a numerical value)
- Reversal of counting direction
- mm/inch
- LOCK function (key lock)
- DATA (data transmission)

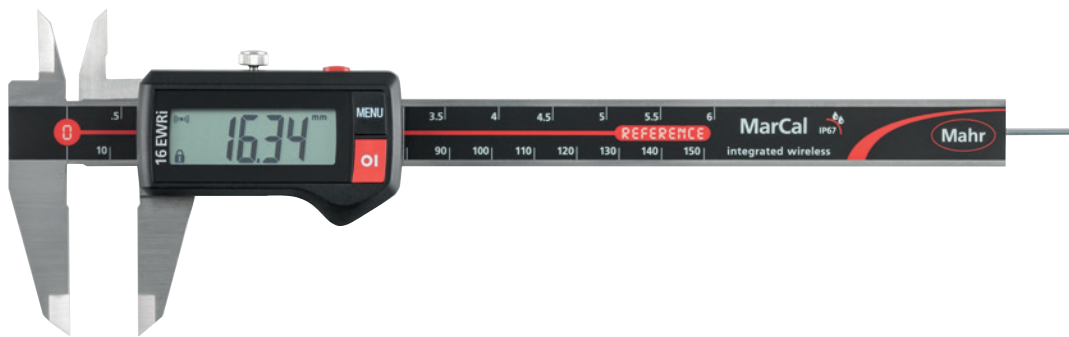

FEATURES

- High contrast analog display
- Locking screw above
- Lapped guideway
- Measuring blade for inside measurements
- Slide and beam made of hardened stainless steel
- Step measuring function
- Immediate measurements due to the Reference System
- Raised guideway for the protection of the scale
- Excellent resistance against dust, coolants and lubricants
- Dirt wipers are integrated in the slide
- SoftwareMarCom Professional free download: www.mahr.com/marcom (only for Mahr data cables and wireless systems with USB and RS232 interface)
- **Digit height:** 11 mm
- **Data interface:** Integrated wireless
- **Energy supply:** Battery life approx. 3 years (approx. 0.5 in wireless mode)
- **IP protection category:** IP 67
- **Package contains:** battery, instruction manual, case

TECHNICAL DATA

Order no.	Type	Measuring range		Numerical increment	Error limit		Standard	Depth rod	Friction wheel
		mm	inch		mm	inch (text)			
4103400	16 EWRI	0-150	0-6"	0.01 / .0005"	0.03	.001"	DIN 862	round	
4103401	16 EWRI	0-150	0-6"	0.01 / .0005"	0.03	.001"	DIN 862	round	•
4103402	16 EWRI	0-150	0-6"	0.01 / .0005"	0.03	.001"	DIN 862	rectangular	
4103403	16 EWRI	0-150	0-6"	0.01 / .0005"	0.03	.001"	DIN 862	rectangular	•
4103404	16 EWRI	0-200	0-8"	0.01 / .0005"	0.03	.001"	DIN 862	rectangular	
4103405	16 EWRI	0-200	0-8"	0.01 / .0005"	0.03	.001"	DIN 862	rectangular	•
4103406	16 EWRI	0-300	0-12"	0.01 / .0005"	0.04	.0015"	Factory standard		
4103407	16 EWRI	0-300	0-12"	0.01 / .0005"	0.04	.0015"	Factory standard		•

Order no.	a	b	c	d	e
	mm	mm	mm	mm	mm
4103400	10	40	16	235	16
4103401	10	40	16s	235	16
4103402	10	40	16	235	16
4103403	10	40	16	235	16
4103404	10	50	19	285	16
4103405	10	50	19	285	16
4103406	14	64	19	388	16
4103407	14	64	19	388	16

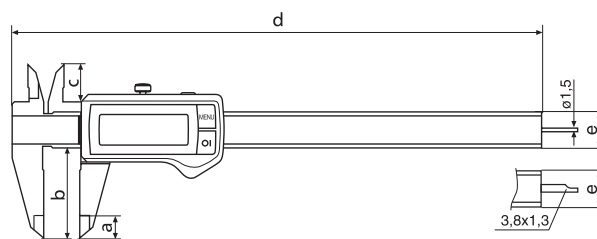

ACCESSORIES

Order no.	Product name	Type
4102020	Depth bridge (75 x 7 mm)	16 Em
4102220	Receiver for instruments with integrated wireless	i-Stick
4102520	Battery 3 V, CR 2032	

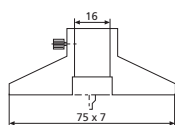

16 Em



i-Stick

MarCal 16 EWR

Digital Caliper



FUNCTIONS

- ON/OFF
- AUTO-ON / OFF
- RESET (set display to zero)
- PRESET (for entering a numerical value)
- Reversal of counting direction
- mm/inch
- LOCK function (key lock)

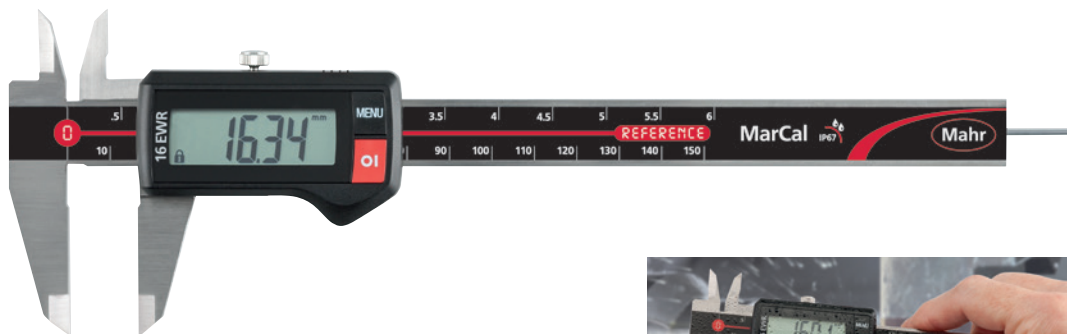

FEATURES

- High contrast analog display
- Locking screw above
- Lapped guideway
- Measuring blade for inside measurements
- Slide and beam made of hardened stainless steel
- Step measuring function
- Immediate measurements due to the Reference System
- Raised guideway for the protection of the scale
- Excellent resistance against dust, coolants and lubricants
- Dirt wipers are integrated in the slide
- **Digit height:** 11 mm
- **Data interface:** none
- **Energy supply:** Battery life approx. 3 years
- **IP protection category:** IP 67
- **Package contains:** battery, instruction manual, case

TECHNICAL DATA

Order no.	Type	Measuring range		Numerical increment	Error limit		Standard	Depth rod	Friction wheel
		mm	inch		mm	inches (text)			
4103300	16 EWR	0 – 150	0 – 6"	0.01 / .0005"	0.03	.001"	DIN 862	round	
4103301	16 EWR	0 – 150	0 – 6"	0.01 / .0005"	0.03	.001"	DIN 862	round	•
4103302	16 EWR	0 – 150	0 – 6"	0.01 / .0005"	0.03	.001"	DIN 862	rectangular	
4103303	16 EWR	0 – 150	0 – 6"	0.01 / .0005"	0.03	.001"	DIN 862	rectangular	•
4103304	16 EWR	0 – 200	0 – 8"	0.01 / .0005"	0.03	.001"	DIN 862	rectangular	
4103305	16 EWR	0 – 200	0 – 8"	0.01 / .0005"	0.03	.001"	DIN 862	rectangular	•
4103306	16 EWR	0 – 300	0 – 12"	0.01 / .0005"	0.04	.0015"	Factory standard		
4103307	16 EWR	0 – 300	0 – 12"	0.01 / .0005"	0.04	.0015"	Factory standard		•

Order no.	a	b	c	d	e
	mm	mm	mm	mm	mm
4103300	10	40	16	235	16
4103301	10	40	16	235	16
4103302	10	40	16	235	16
4103303	10	40	16	235	16
4103304	10	50	19	285	16
4103305	10	50	19	285	16
4103306	14	64	19	388	16
4103307	14	64	19	388	16

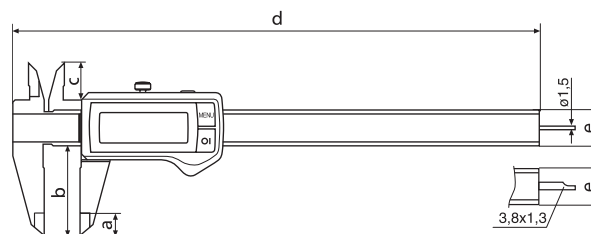

ACCESSORIES

Order no.	Product name	Type
4102020	Depth bridge (75 x 7 mm)	16 Em
4102520	Battery 3 V, CR 2032	

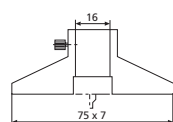

16 Em

MarCal 16 EWR

Digital Caliper



FUNCTIONS

- ON/OFF
- AUTO-ON / OFF
- RESET (set display to zero)
- mm/inch
- LOCK function (key lock)
- DATA (data transmission via connection cable)

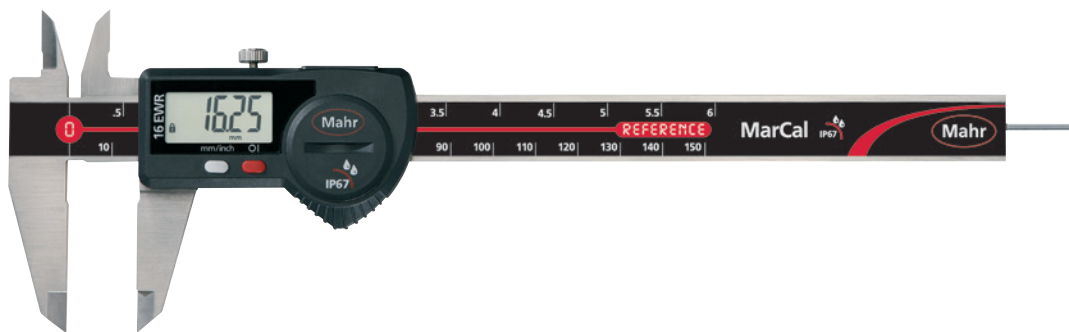

FEATURES

- High contrast analog display
- Locking screw above
- Lapped guideway
- Measuring blade for inside measurements
- Slide and beam made of hardened stainless steel
- Step measuring function
- Immediate measurements due to the Reference System
- Raised guideway for the protection of the scale
- Excellent resistance against dust, coolants and lubricants
- Dirt wipers are integrated in the slide
- SoftwareMarCom Professional free download: www.mahr.com/marcom (only for Mahr data cables and wireless systems with USB and RS232 interface)
- **Digit height:** 8.5 mm
- **Data interface:** USB, Opto RS232C, Digimatic
- **Energy supply:** Battery life approx. 3 years
- **IP protection category:** IP 67
- **Package contains:** battery, instruction manual, case

TECHNICAL DATA

Order no.	Type	Measuring range		Numerical increment	Error limit		Standard	Depth rod	Friction wheel
		mm	inch		mm/inch	mm			
4103064	16 EWR	0-150	0-6"	0.01 / .0005"	0.03	.001"	DIN 862	round	
4103065	16 EWR	0-150	0-6"	0.01 / .0005"	0.03	.001"	DIN 862	round	•
4103066	16 EWR	0-150	0-6"	0.01 / .0005"	0.03	.001"	DIN 862	rectangular	
4103067	16 EWR	0-150	0-6"	0.01 / .0005"	0.03	.001"	DIN 862	rectangular	•
4103068	16 EWR	0-200	0-8"	0.01 / .0005"	0.03	.001"	DIN 862	rectangular	
4103069	16 EWR	0-200	0-8"	0.01 / .0005"	0.03	.001"	DIN 862	rectangular	•
4103070	16 EWR	0-300	0-12"	0.01 / .0005"	0.04	.0015"	Factory standard		
4103071	16 EWR	0-300	0-12"	0.01 / .0005"	0.04	.0015"	Factory standard		•

Order no.	a	b	c	d	e
	mm	mm	mm	mm	mm
4103064	10	40	16	235	16
4103065	10	40	16	235	16
4103066	10	40	16	235	16
4103067	10	40	16	235	16
4103068	10	50	19	285	16
4103069	10	50	19	285	16
4103070	14	64	19	388	16
4103071	14	64	19	388	16

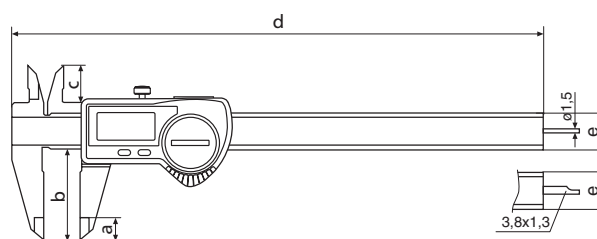

ACCESSORIES

Order no.	Product name	Type
4102020	Depth bridge (75 x 7 mm)	16 Em
4102357	16 EXu data connection cable USB (2 m)	16 EXu
4102410	Data connection cable RS232C (2 m)	16 EXr
4102520	Battery 3 V, CR 2032	
4102915	Digimatic data cable (2 m)	16 EWd

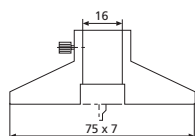

16 Em

MarCal 16 ER

Digital Caliper



FUNCTIONS

- ON/OFF
- AUTO-ON / OFF
- RESET (set display to zero)
- mm/inch
- LOCK function (key lock)

FEATURES

- High contrast analog display
- Locking screw above
- Lapped guideway
- Measuring blade for inside measurements
- Slide and beam made of hardened stainless steel
- Step measuring function
- Immediate measurements due to the Reference System
- Raised guideway for the protection of the scale
- Dirt wipers are integrated in the slide
- **Digit height:** 11 mm
- **Data interface:** none
- **Energy supply:** Battery life approx. 3 years
- **IP protection category:** None
- **Package contains:** instruction manual, battery, case

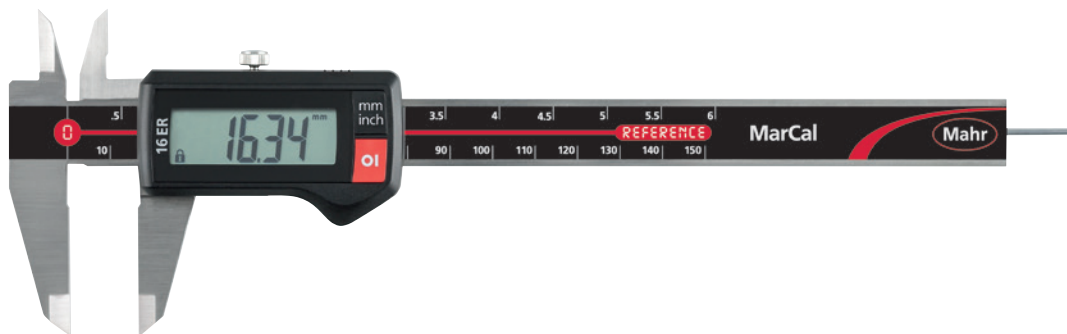

TECHNICAL DATA

Order no.	Type	Measuring range		Numerical increment	Error limit		Standard	Depth rod	Friction wheel
		mm	inch		mm	inches (text)			
4103010	16 ER	0 – 150	0 – 6"	0.01 / .0005"	0.03	.001"	DIN 862	round	
4103011	16 ER	0 – 150	0 – 6"	0.01 / .0005"	0.03	.001"	DIN 862	round	•
4103012	16 ER	0 – 150	0 – 6"	0.01 / .0005"	0.03	.001"	DIN 862	rectangular	
4103013	16 ER	0 – 150	0 – 6"	0.01 / .0005"	0.03	.001"	DIN 862	rectangular	•
4103205	16 ER	0 – 200	0 – 8"	0.01 / .0005"	0.03	.001"	DIN 862	rectangular	
4103206	16 ER	0 – 200	0 – 8"	0.01 / .0005"	0.03	.001"	DIN 862	rectangular	•
4103207	16 ER	0 – 300	0 – 12"	0.01 / .0005"	0.04	.0015"	Factory standard		
4103208	16 ER	0 – 300	0 – 12"	0.01 / .0005"	0.04	.0015"	Factory standard		•

Order no.	a	b	c	d	e
	mm	mm	mm	mm	mm
4103010	10	40	16	235	16
4103011	10	40	16	235	16
4103012	10	40	16	235	16
4103013	10	40	16	235	16
4103205	10	50	19	285	16
4103206	10	50	19	285	16
4103207	14	64	19	388	16
4103208	14	64	19	388	16

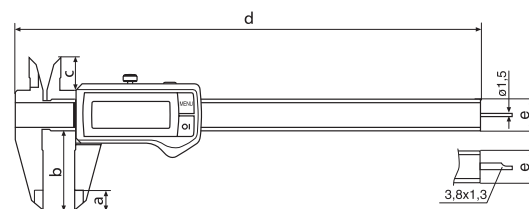

ACCESSORIES

Order no.	Product name	Type
4102020	Depth bridge (75 x 7 mm)	16 Em
4102520	Battery 3 V, CR 2032	

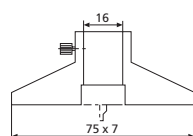

16 Em

MarCal 16 ER

Digital Caliper



FUNCTIONS

- ON/OFF
- AUTO-ON / OFF
- RESET (set display to zero)
- mm/inch
- LOCK function (key lock)
- DATA (data transmission via connection cable)

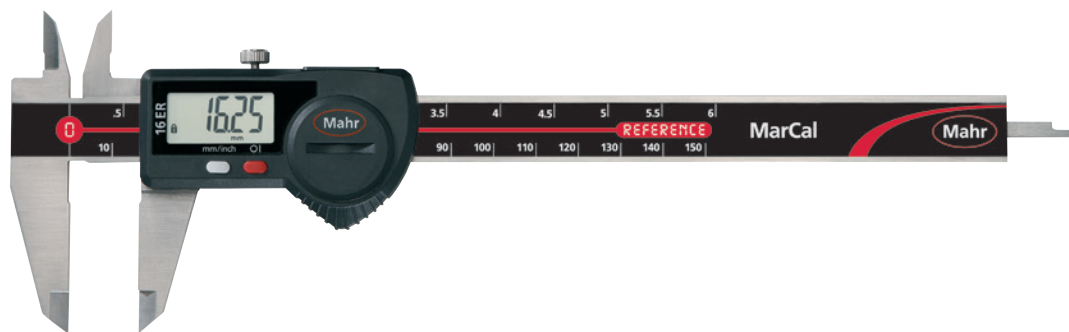

FEATURES

- High contrast analog display
- Locking screw above
- Lapped guideway
- Measuring blade for inside measurements
- Slide and beam made of hardened stainless steel
- Step measuring function
- Immediate measurements due to the Reference System
- Raised guideway for the protection of the scale
- Dirt wipers are integrated in the slide
- SoftwareMarCom Professional free download: www.mahr.com/marcom (only for Mahr data cables and wireless systems with USB and RS232 interface)
- **Digit height:** 8.5 mm
- **Data interface:** USB, Opto RS232C, Digimatic
- **Energy supply:** Battery life approx. 3 years
- **IP protection category:** None
- **Package contains:** instruction manual, battery, case

TECHNICAL DATA

Order no.	Type	Measuring range		Numerical increment	Error limit		Standard	Depth rod	Friction wheel
		mm	inch		mm	inch (text)			
4103014	16 ER	0 – 150	0 – 6"	0.01 / .0005"	0.03	.001"	DIN 862	round	
4103015	16 ER	0 – 150	0 – 6"	0.01 / .0005"	0.03	.001"	DIN 862	round	•
4103016	16 ER	0 – 150	0 – 6"	0.01 / .0005"	0.03	.001"	DIN 862	rectangular	
4103017	16 ER	0 – 150	0 – 6"	0.01 / .0005"	0.03	.001"	DIN 862	rectangular	•
4103018	16 ER	0 – 200	0 – 8"	0.01 / .0005"	0.03	.001"	DIN 862	rectangular	
4103019	16 ER	0 – 200	0 – 8"	0.01 / .0005"	0.03	.001"	DIN 862	rectangular	•
4103020	16 ER	0 – 300	0 – 12"	0.01 / .0005"	0.04	.0015"	Factory standard		
4103021	16 ER	0 – 300	0 – 12"	0.01 / .0005"	0.04	.0015"	Factory standard		•

Order no.	a	b	c	d	e
	mm	mm	mm	mm	mm
4103014	10	40	16	235	16
4103015	10	40	16	235	16
4103016	10	40	16	235	16
4103017	10	40	16	235	16
4103018	10	50	19	285	16
4103019	10	50	19	285	16
4103020	14	64	19	388	16
4103021	14	64	19	388	16

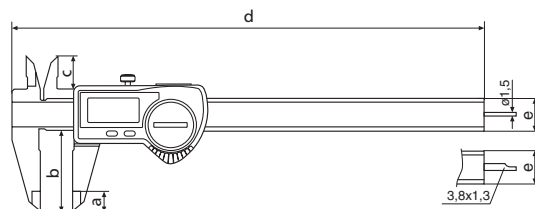

ACCESSORIES

Order no.	Product name	Type
4102020	Depth bridge (75 x 7 mm)	16 Em
4102357	16 EXu data connection cable USB (2 m)	16 EXu
4102410	Data connection cable RS232C (2 m)	16 EXr
4102520	Battery 3 V, CR 2032	
4102915	Digimatic data cable (2 m)	16 EWd

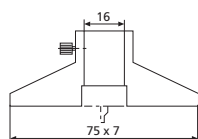

16 Em

MarCal 16 U

Dial Caliper



SHOCK
PROOF

DIN
862

FEATURES

- Large, high contrast dial face
- Shockproof movement
- Zero setting through rotating the dial face and locking screw
- Satin chrome finished line scale
- Locking screw above
- Measuring surfaces made of steel
- Measuring blade for inside measurements
- Slide and beam made of hardened stainless steel
- Step measuring function
- Raised guideway for the protection of the scale
- Package contains: case



TECHNICAL DATA

Order no.		4107005	4107107	4107900
Type		16 U		
Measuring range	mm	0 – 150		
Measuring range inch	inch	0 – 6"		
Readings	mm	0.01	0.02	
Scale graduation value	inch	.0001"		
Range per rev. in inches (text)	inch	.100"		
Range per rev.	mm	1	2	
Error limit	mm	0.03		
Error limit inches (text)	inch	.0012"		
Standard		DIN 862		Factory standard
Dial color		White		Black
Depth rod		rectangular		
Friction wheel		•		

Order no.	a	b	c	d	e
	mm	mm	mm	mm	mm
4107005	10	40	16.5	234	16
4107107	10	40	16.5	234	16
4107900	10	40	16.5	234	16

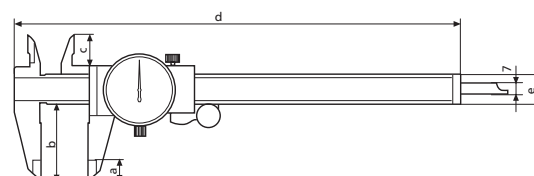

ACCESSORIES

Order no.	Product name	Type
4102020	Depth bridge (75 x 7 mm)	16 Em
4100302	Synthetic leather pouch, black for pocket slide caliper 150 mm	

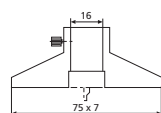

16 Em

MarCal 16 FN / 16 GN

Caliper with Analog Display



DIN 862

FEATURES

- Vernier and scale have a satin chrome finish for glare free reading
- Locking screw above
- Measuring surfaces made of steel
- Measuring blade for inside measurements
- Slide and beam made of hardened stainless steel
- Step measuring function
- Raised guideway for the protection of the scale
- Package contains: thread table, case

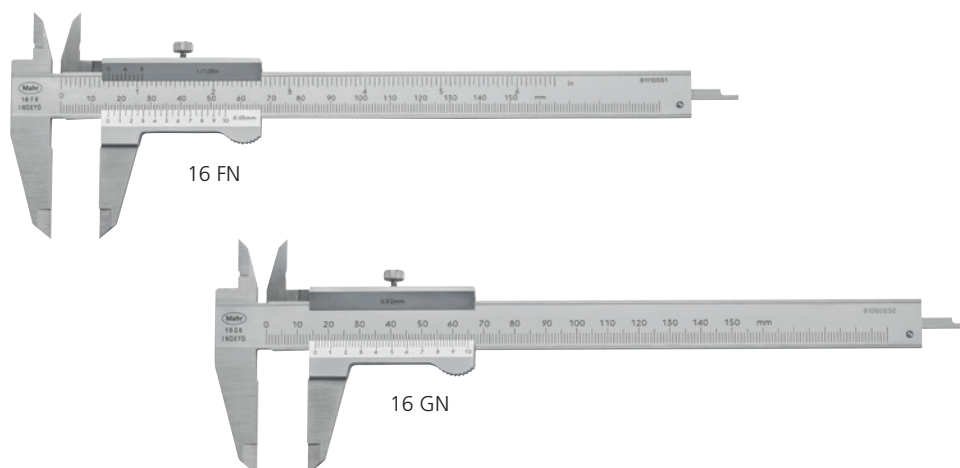

TECHNICAL DATA

Order no.	Type	Measuring range mm	Measuring range inch	Vernier value mm	Vernier value inch	Error limit mm	Error limit inches (text)	Standard	Depth rod
4100400	16 FN	0-150	0-6"	0.05	1/128"	0.05	.002"	DIN 862	rectangular
4100401	16 FN	0-200	0-8"	0.05	1/128"	0.05	.002"	DIN 862	rectangular
4100402	16 FN	0-300	0-12"	0.05	1/128"	0.05	.002"	DIN 862	rectangular
4100420	16 FN	0-150		0.05		0.05		DIN 862	rectangular
4100421	16 FN	0-200		0.05		0.05		DIN 862	rectangular
4100422	16 FN	0-300		0.05		0.05		DIN 862	rectangular
4100650	16 GN	0-150		0.02		0.05		Factory standard	rectangular
4100651	16 GN	0-200		0.02		0.05		Factory standard	rectangular
4100652	16 GN	0-300		0.02		0.05		Factory standard	rectangular

Order no.	a	b	c	d	e	f
	mm	mm	mm	mm	mm	mm
4100400	10	40	16	228	16	3.8
4100401	14	50	19	290	17	3.8
4100402	16	64	23	404	20	4.8
4100420	10	40	16	228	16	3.8
4100421	14	50	19	290	17	3.8
4100422	16	64	23	404	20	4.8
4100650	10	40	16	228	16	3.8
4100651	14	50	19	290	17	3.8
4100652	16	64	23	404	20	4.8

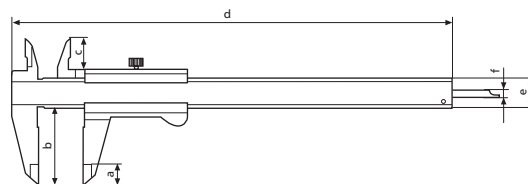

ACCESSORIES

Order no.	Product name	Type
4100302	Synthetic leather pouch, black for pocket slide caliper 150 mm	
4102020	Depth bridge (75 x 7 mm)	16 Em

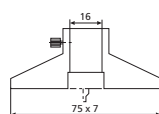

16 Em

MarCal 16 DN

Caliper with Analog Display



DIN 862

FEATURES

- Vernier and scale have a satin chrome finish for glare free reading
- Thumb clamp
- Measuring surfaces made of steel
- Measuring blade for inside measurements
- Slide and beam made of hardened stainless steel
- Step measuring function
- Raised guideway for the protection of the scale
- Package contains: thread table, case

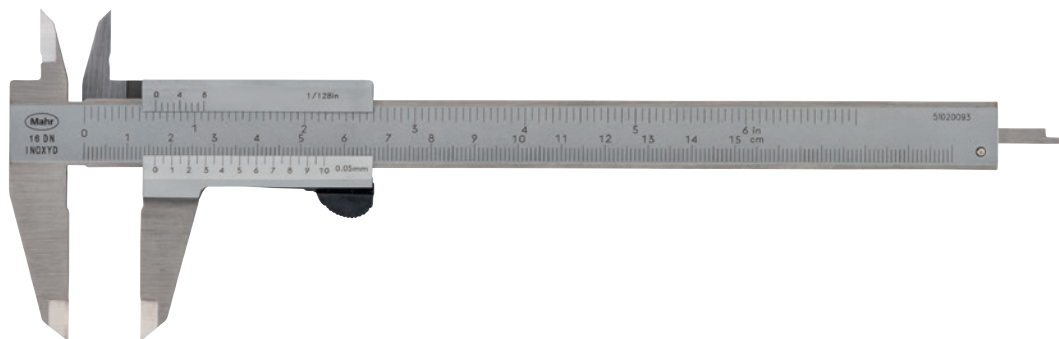

TECHNICAL DATA

Order no.	Type	Measuring range mm	Measuring range inch	Vernier value mm	Vernier value inch	Error limit mm	Error limit inches (text)	Standard	Depth rod
4100600	16 DN	0 – 150	0 – 6"	0.05	1/128"	0.05	.002"	DIN 862	rectangular

Order no.	a	b	c	d	e	f
4100600	10	40	16	228	16	3.8

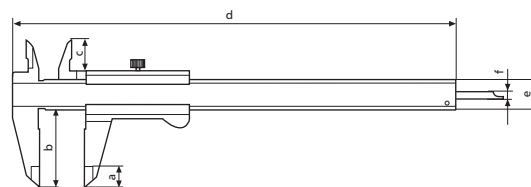

ACCESSORIES

Order no.	Product name	Type
4100302	Synthetic leather pouch, black for pocket slide caliper 150 mm	
4102020	Depth bridge (75 x 7 mm)	16 Em

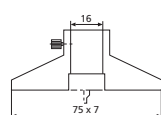

16 Em

MarCal 16 EWRI-V

Digital Universal Caliper



FUNCTIONS

- AUTO-ON / OFF
- ON/OFF
- DATA (data transmission via connection cable)
- HOLD (storage of measured values)
- PRESET (for entering a numerical value)
- RESET (set display to zero)
- mm/inch
- LOCK function (key lock)



FEATURES

- High contrast analog display
- Locking screw above
- Lapped guideway
- Measuring blade for inside measurements
- Slide and beam made of hardened stainless steel
- Step measuring function
- Immediate measurements due to the Reference System
- Raised guideway for the protection of the scale
- Excellent resistance against dust, coolants and lubricants
- Dirt wipers are integrated in the slide
- SoftwareMarCom Professional free download: www.mahr.com/marcom (only for Mahr data cables and wireless systems with USB and RS232 interface)
- **Digit height:** 11 mm
- **Data interface:** Integrated wireless
- **Energy supply:** Battery life approx. 3 years (approx. 0.5 in wireless mode)
- **IP protection category:** IP 67
- **Package contains:** battery, instruction manual, case, Setting gage for inside measurement 16 Eel, measuring force device 16 Ec, depth measuring bridge 16 Em, anvils for outside measurement 16 Eea 1-3, anvils for inside measurement 16Eei 1-3

Application:

- Can be used as standard calipers (four measuring directions) with standard accessories for measuring recesses, grooves, etc.
- Can be used with special accessories for measuring threads, bores and gears



TECHNICAL DATA

Order no.	Type	Measuring range	Measuring range	Numerical increment	Error limit	Error limit	Standard	Depth rod	Incl. accessories
		mm	inch	mm/inch	mm	inch			
4118907	16 EWRI-V	0-200	0-8"	0.01 / .0005"	0.03	.001"	DIN 862	rectangular	•

Order no.	b	c	d	e
	mm	mm	mm	mm
4118907	48	16.5	285	16

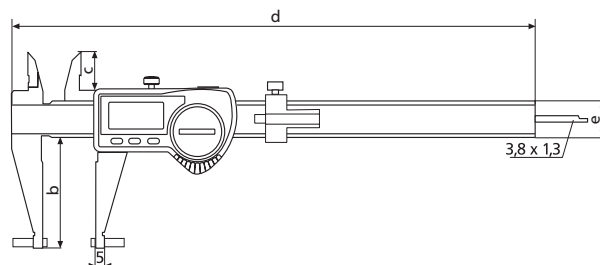

MarCal 16 EWri-V

Digital Universal Caliper

ACCESSORIES

Order no.	Quantity unit	Product name	Type
4102020		Depth bridge (75 x 7 mm)	16 Em
4118810	Piece	Anvil for outside measurement (3.5 x 12 mm)	16 Eea 1
4118811	Piece	Anvil for outside measurement (1.5 x 6 mm)	16 Eea 2
4118812	Piece	Anvil for outside measurement (3.5 x 6 mm)	16 Eea 3
4118813	Piece	Anvil for inside measurement (3.5 x 6 mm)	16 Eei 1
4118814	Piece	Anvil for inside measurement (1.5 x 6 mm)	16 Eei 2
4118815	Piece	Anvil for inside measurement (3.5 x 6 mm)	16 Eei 3
4118816	Piece	Anvil for inside measurement (4 x 2.5 mm)	16 Eei 4
4118817		Setting gage for inside measurement (50 mm)	16 Eel
4118818		Measuring force device	16 Ec
4879602	Piece	Screws M2x8	
4118819		Mounting attachment for thread anvils 844 TG/844Tr and ball anvils 844 Tk	16 Eab
4102220		Receiver for instruments with integrated wireless	i-Stick
4102520		Battery 3 V, CR 2032	

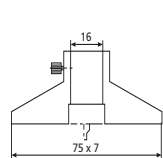

16 Em

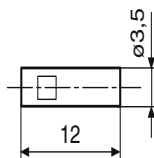

16 Eea 1

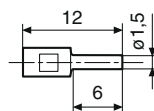

16 Eea 2

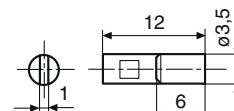

16 Eea 3

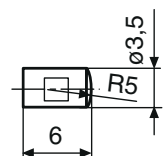

16 Eei 1

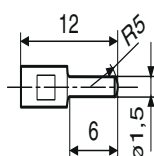

16 Eei 2

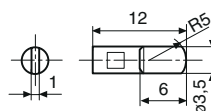

16 Eei 3

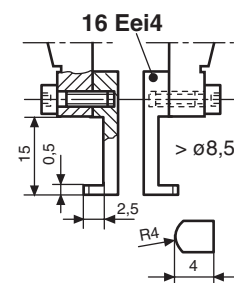

16 Eei 4

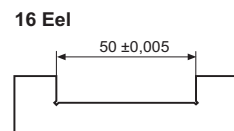

16 Eel

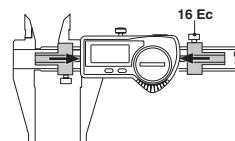

16 Ec

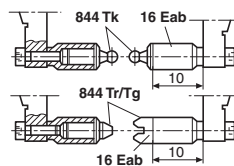

16 Eab

MarCal 16 EWR-V

Digital Universal Caliper



FUNCTIONS

- AUTO-ON / OFF
- DATA (data transmission via connection cable)
- ON/OFF
- PRESET (for entering a numerical value)
- RESET (set display to zero)
- mm/inch
- LOCK function (key lock)

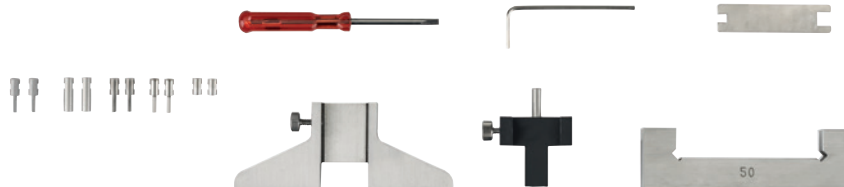
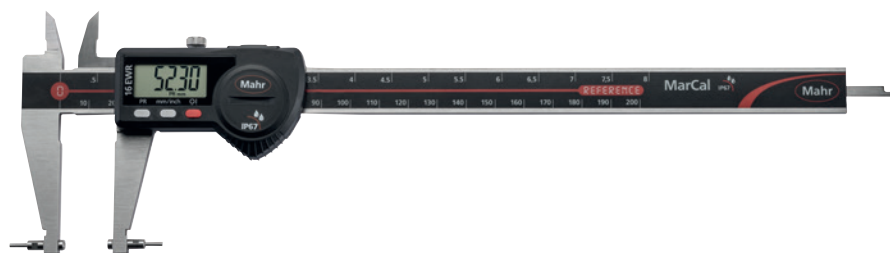

FEATURES

- High contrast analog display
- Locking screw above
- Lapped guideway
- Measuring blade for inside measurements
- Slide and beam made of hardened stainless steel
- Step measuring function
- Immediate measurements due to the Reference System
- Raised guideway for the protection of the scale
- Excellent resistance against dust, coolants and lubricants
- Dirt wipers are integrated in the slide
- SoftwareMarCom Professional free download: www.mahr.com/marcom (only for Mahr data cables and wireless systems with USB and RS232 interface)
- **Digit height:** 8.5 mm
- **Data interface:** USB, Opto RS232C, Digimatic, wireless
- **Energy supply:** Battery life approx. 3 years
- **IP protection category:** IP 67
- **Package contains:** battery, instruction manual, case, Setting gage for inside measurement 16 Eel, measuring force device 16 Ec, depth measuring bridge 16 Ee, anvils for outside measurement 16 Eea 1-3, anvils for inside measurement 16 Eei 1-3, 4118808 without measuring anvils, adjustment bridge and measuring force equipment

Application:

- Can be used as a standard caliper (four types of measurements) with standard accessories to measure recesses, grooves, etc.
- Can be used with additional accessories to measure threads, bores and serration

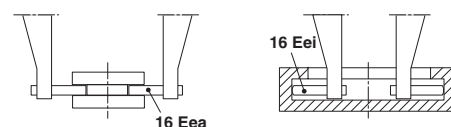

TECHNICAL DATA

Order no.	Type	Measuring range	Measuring range inch	Numerical increment	Error limit	Error limit inches (text)	Standard	Depth rod	Incl. accessories
4118807	16 EWR-V	0 - 200	0 - 8"	mm/inch 0.01 / .0005"	mm 0.03	inch .001"	DIN 862	rectangular	•

Order no.	b	c	d	e
4118807	mm 48	mm 16.5	mm 285	mm 16

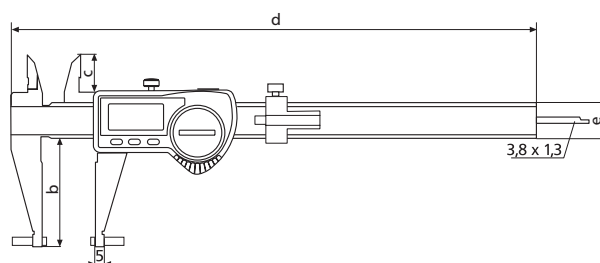

MarCal 16 EWR-V

Digital Universal Caliper

ACCESSORIES

Order no.	Quantity unit	Product name	Type
4118810	Piece	Anvil for outside measurement (3.5 x 12 mm)	16 Eea 1
4118811	Piece	Anvil for outside measurement (1.5 x 6 mm)	16 Eea 2
4118812	Piece	Anvil for outside measurement (3.5 x 6 mm)	16 Eea 3
4118813	Piece	Anvil for inside measurement (3.5 x 6 mm)	16 Eei 1
4118814	Piece	Anvil for inside measurement (1.5 x 6 mm)	16 Eei 2
4118815	Piece	Anvil for inside measurement (3.5 x 6 mm)	16 Eei 3
4118816	Piece	Anvil for inside measurement (4 x 2.5 mm)	16 Eei 4
4118817		Setting gage for inside measurement (50 mm)	16 Eel
4118818		Measuring force device	16 Ec
4879602	Piece	Screws M2x8	
4118819		Mounting attachment for thread anvils 844 TG/844Tr and ball anvils 844 Tk	16 Eab
4102020		Depth bridge (75 x 7 mm)	16 Em
4102357		16 EXu data connection cable USB (2 m)	16 EXu
4102915		Digimatic data cable (2 m)	16 EWd
4102410		Data connection cable RS232C (2 m)	16 EXr
4102520		Battery 3 V, CR 2032	

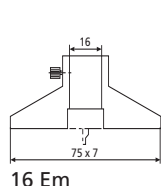

16 Em

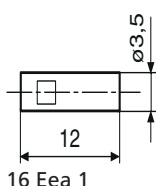

16 Eea 1

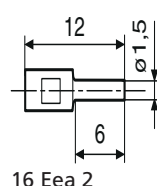

16 Eea 2

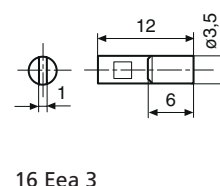

16 Eea 3

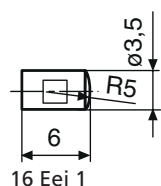

16 Eei 1

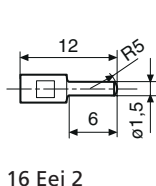

16 Eei 2

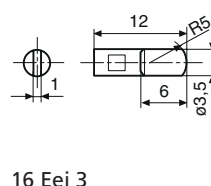

16 Eei 3

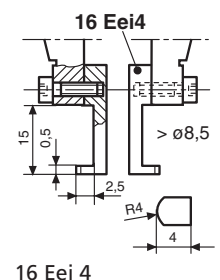

16 Eei 4

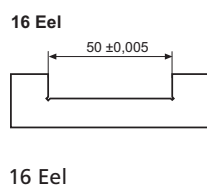

16 Eel

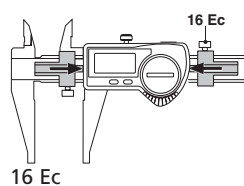

16 Ec

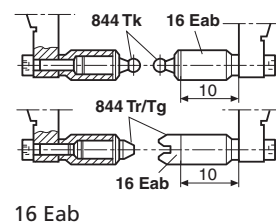

16 Eab

MarCal 18 EWR-V

Digital Universal Caliper



FUNCTIONS

- ON/OFF
- AUTO-ON / OFF
- RESET (set display to zero)
- PRESET (for entering a numerical value)
- mm/inch
- LOCK function (key lock)
- DATA (data transmission via connection cable)

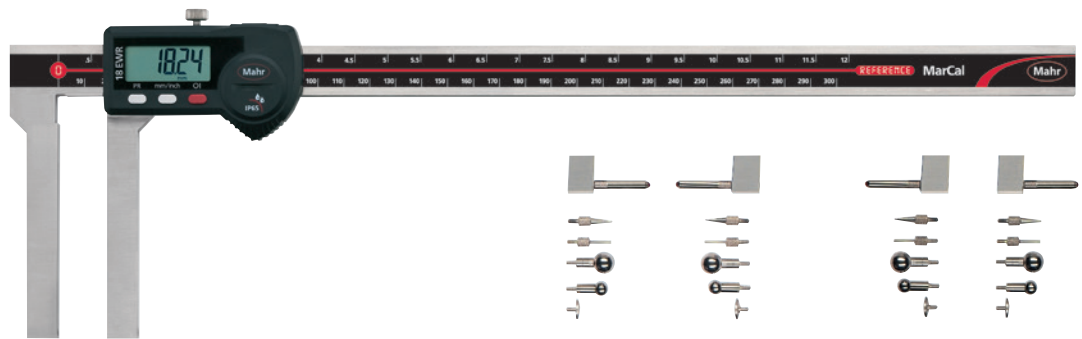

FEATURES

- High contrast analog display
- Locking screw above
- Immediate measurements due to the Reference System
- Excellent resistance against dust, coolants and lubricants
- Dirt wipers are integrated in the slide
- Slide and beam made of hardened stainless steel
- Measuring faces for outside measurement
- Thread M2.5 measuring jaws to accommodate measuring anvils for internal and external measurements
- SoftwareMarCom Professional free download: www.mahr.com/marcom (only for Mahr data cables and wireless systems with USB and RS232 interface)
- **Digit height:** 10 mm (300 mm), 12.5 mm (500mm)
- **Data interface:** USB, Opto RS232C, Digimatic, wireless
- **Energy supply:** Battery life approx. 3 years
- **IP protection category:** IP 65
- **Package contains:** battery, case, instruction manual, anvils

Application:

- For inner and outer measurements of recesses, grooves, etc.
- Individual adjustment by means of measuring anvils with M2.5 thread

TECHNICAL DATA

Order no.	Type	Measuring range		Numerical increment	Error limit		Standard
		mm	inch		mm	inch (text)	
4112722	18 EWR-V	0 – 300	0 – 12"	0.01 / .0005"	0.06	.0025"	Factory standard
4112723	18 EWR-V	0 – 500	0 – 20"	0.01 / .0005"	0.08	.003"	Factory standard

Order no.	a	b	c	d	e
	mm	mm	mm	mm	mm
4112722	410	90	12	75.5	20
4112723	680	100	16	81	25

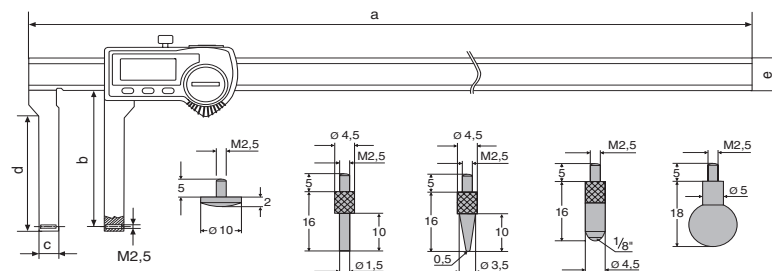

ACCESSORIES

Order no.	Product name	Quantity	unit	Type
4102230	Receiver			e-Stick
4102231	Transmitter for e-Stick			16 EWe
4102357	16 EXu data connection cable USB (2 m)			16 EXu
4102410	Data connection cable RS232C (2 m)			16 EXr
4102520	Battery 3 V, CR 2032			
4102915	Digimatic data cable (2 m)			16 EWd
4112050	Replacement measuring anvil: Spherical plate ø 10.0 mm	Piece		
4112051	Replacement measuring anvil: Cylindrical stylus ø 1.5 mm x 10 mm	Piece		
4112052	Replacement measuring anvil: Tip, radius 0.5 mm x 10 mm	Piece		
4112053	Replacement measuring anvil: Sphere diameter 1/8" length 16 mm	Piece		
4112054	Replacement measuring anvil: Ball dia. 7.0 mm	Piece		
4112055	Replacement measuring anvil: Sphere ø 10.0 mm	Piece		



16 EWe



e-Stick

MarCal 16 EWri-C / 16 EWR-C

Digital Caliper for Special Applications

FUNCTIONS 16 EWri-C

- ON/OFF
- AUTO-ON / OFF
- mm/inch
- LOCK function (key lock)
- RESET (set display to zero)
- PRESET (for entering a numerical value)
- DATA (data transmission)
- HOLD (storage of measured values)

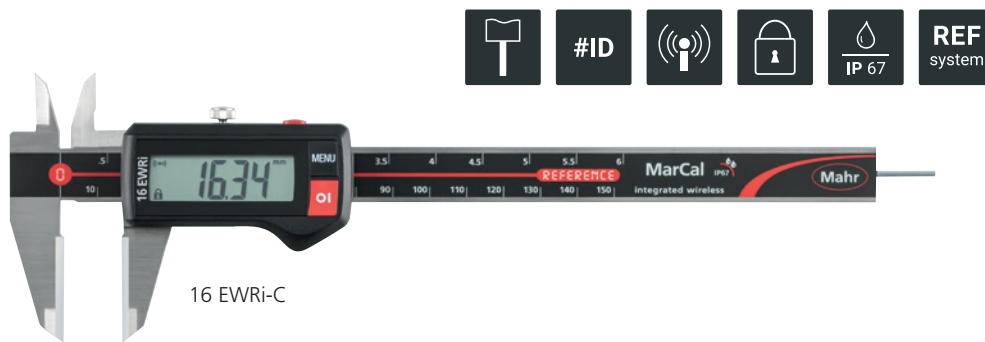

16 EWri-C

FUNCTIONS 16 EWR-C

- ON/OFF
- AUTO-ON / OFF
- mm/inch
- LOCK function (key lock)
- RESET (set display to zero)
- DATA (data transmission via connection cable)
- High contrast analog display
- Locking screw above
- Lapped guideway
- Measuring blade for inside measurements
- Slide and beam made of hardened stainless steel
- Step measuring function
- Immediate measurements due to the Reference System
- Raised guideway for the protection of the scale
- Excellent resistance against dust, coolants and lubricants
- Dirt wipers are integrated in the slide



16 EWR-C

Application:

Outer measuring surfaces made of ceramic, for measuring hard materials

TECHNICAL DATA

Order no.	Type	Measuring range		Numerical increment	Error limit		Standard	Depth rod
		mm	inch		mm	inch (text)		
4103372	16 EWri-C	0 – 150	0 – 6"	0.01 / .0005"	0.03	.001"	DIN 862	round
4103072	16 EWR-C	0 – 150	0 – 6"	0.01 / .0005"	0.03	.001"	DIN 862	round

Order no.	a	b	c	d	e
4103372	10	40	16	235	16
4103072	10	40	16	235	16

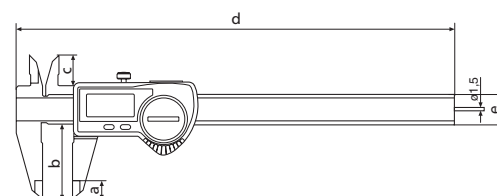

FEATURES 16 EWri-C

- SoftwareMarCom Professional free download: www.mahr.com/marcom (only for Mahr data cables and wireless systems with USB and RS232 interface)
- **Digit height:** 11 mm
- **Data interface:** Integrated wireless
- **Energy supply:** Battery life approx. 3 years (approx. 0.5 in wireless mode)
- **IP protection category:** IP 67
- **Package contains:** battery, instruction manual, case

FEATURES 16 EWR-C

- **Digit height:** 8.5 mm
- **Data interface:** USB, Opto RS232C, Digimatic
- **Energy supply:** Battery life approx. 3 years

ACCESSORIES

Order no.	For measuring instrument	Product name	Type
4102220	16 EWri-C	Receiver for instruments with integrated wireless	i-Stick
4102357	16 EWR-C	16 EXu data connection cable USB (2 m)	16 EXu
4102410	16 EWR-C	Data connection cable RS232C (2 m)	16 EXr
4102520	16 EWR-C, 16 EWri-C	Battery 3 V, CR 2032	
4102915	16 EWR-C	Digimatic data cable (2 m)	16 EWd



i-Stick

MarCal 16 EWRI-H / 16 EWR-H

Digital Caliper for Special Applications

FUNCTIONS 16 EWRI-H

- ON/OFF
- AUTO-ON / OFF
- mm/inch
- LOCK function (key lock)
- RESET (set display to zero)
- PRESET (for entering a numerical value)
- DATA (data transmission)
- HOLD (storage of measured values)



16 EWRI-H

FUNCTIONS 16 EWR-H

- ON/OFF
- AUTO-ON / OFF
- mm/inch
- LOCK function (key lock)
- RESET (set display to zero)
- DATA (data transmission via connection cable)
- High contrast analog display
- Locking screw above
- Lapped guideway
- Measuring blade for inside measurements
- Slide and beam made of hardened stainless steel
- Step measuring function
- Immediate measurements due to the Reference System
- Raised guideway for the protection of the scale
- Excellent resistance against dust, coolants and lubricants
- Dirt wipers are integrated in the slide

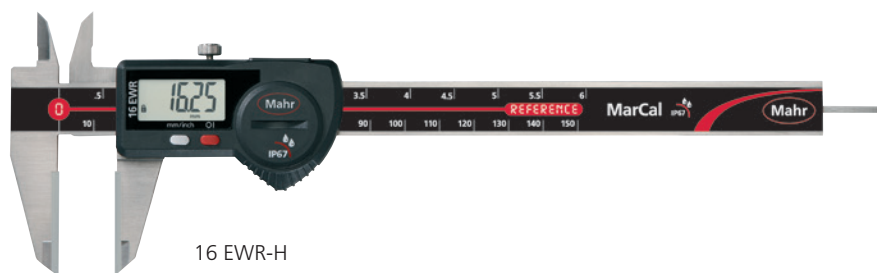

16 EWR-H

Application:

Outer measuring surfaces made of carbide, for measuring hard materials

TECHNICAL DATA

Order no.	Type	Measuring range		Numerical increment	Error limit		Standard	Depth rod
		mm	inch		mm	inches (text)		
4103373	16 EWRI-H	0 - 150	0 - 6"	0.01 / .0005"	0.03	.001"	DIN 862	round
4103073	16 EWR-H	0 - 150	0 - 6"	0.01 / .0005"	0.03	.001"	DIN 862	round

Order no.	a	b	c	d	e
	mm	mm	mm	mm	mm
4103373	10	40	16	235	16
4103073	10	40	16	235	16

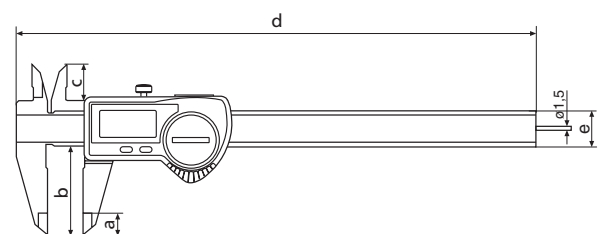

FEATURES 16 EWRI-H

- Software MarCom Professional free download: www.mahr.com/marcom (only for Mahr data cables and wireless systems with USB and RS232 interface)
- **Digit height:** 11 mm
- **Data interface:** Integrated wireless
- **Energy supply:** Battery life approx. 3 years (approx. 0.5 in wireless mode)
- **IP protection category:** IP 67
- **Package contains:** battery, instruction manual, case

FEATURES 16 EWR-H

- **Digit height:** 8.5 mm
- **Data interface:** USB, Opto RS232C, Digimatic
- **Energy supply:** Battery life approx. 3 years

ACCESSORIES

Order no.	For measuring instrument	Product name	Type
4102220	16 EWRI-H	Receiver for instruments with integrated wireless	i-Stick
4102357	16 EWR-H	16 EXu data connection cable USB (2 m)	16 EXu
4102410	16 EWR-H	Data connection cable RS232C (2 m)	16 EXr
4102520	16 EWR-H, 16 EWRI-H	Battery 3 V, CR 2032	
4102915	16 EWR-H	Digimatic data cable (2 m)	16 EWD



i-Stick

MarCal 16 EWri-AR / 16 EWR-AR

Digital Caliper for Special Applications

FUNCTIONS 16 EWri-AR

- ON/OFF
- AUTO-ON / OFF
- mm/inch
- LOCK function (key lock)
- RESET (set display to zero)
- PRESET (for entering a numerical value)
- DATA (data transmission)
- HOLD (storage of measured values)

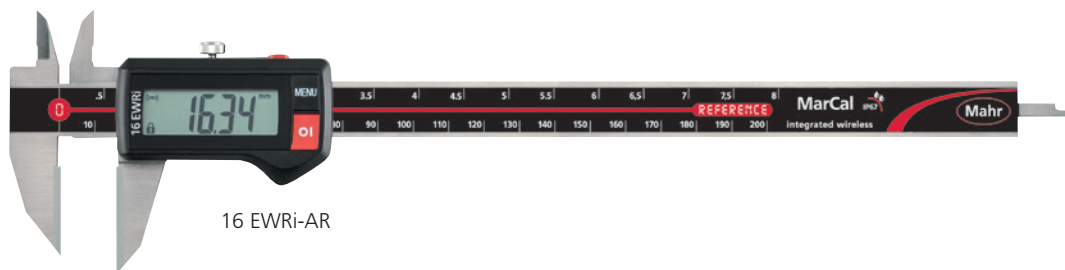

16 EWri-AR



FUNCTIONS 16 EWR-AR

- ON/OFF
- AUTO-ON / OFF
- mm/inch
- LOCK function (key lock)
- RESET (set display to zero)
- DATA (data transmission via connection cable)
- High contrast analog display
- Locking screw above
- Lapped guideway
- Measuring blade for inside measurements
- Slide and beam made of hardened stainless steel
- Step measuring function
- Immediate measurements due to the Reference System
- Raised guideway for the protection of the scale
- Excellent resistance against dust, coolants and lubricants
- Dirt wipers are integrated in the slide

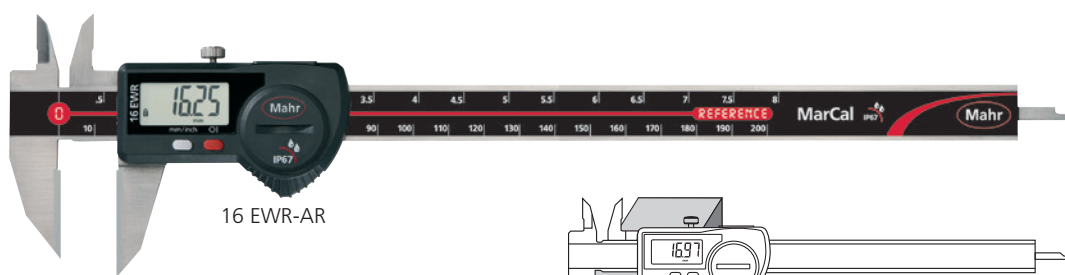

16 EWR-AR



Application:

- Outer measuring surfaces made of carbide
- For marking out workpieces

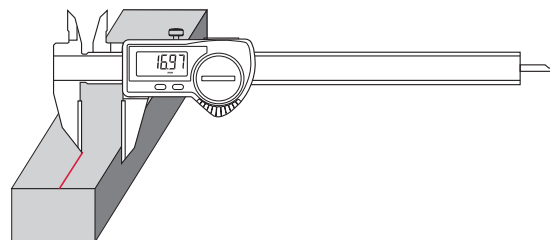

TECHNICAL DATA

Order no.	Type	Measuring range		Numerical increment	Error limit		Standard	Depth rod
		mm	inch		mm	inches (text)		
4103382	16 EWri-AR	0 - 200	0 - 8"	0.01 / .0005"	0.03	.001"	Factory standard	rectangular
4103082	16 EWR-AR	0 - 200	0 - 8"	0.01 / .0005"	0.03	.001"	Factory standard	rectangular

Order no.	c	d	e
	mm	mm	mm
4103382	16.5	285	16
4103082	16.5	285	16

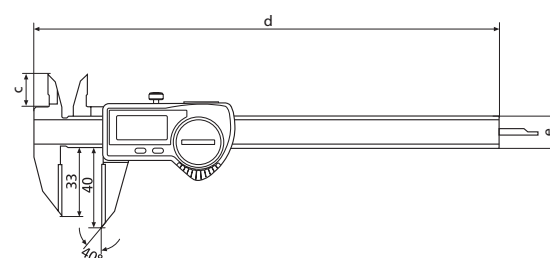

FEATURES 16 EWri-AR

- Software MarCom Professional free download: www.mahr.com/marcom (only for Mahr data cables and wireless systems with USB and RS232 interface)
- Digit height: 11 mm
- Data interface: Integrated wireless
- Energy supply: Battery life approx. 3 years (approx. 0.5 in wireless mode)
- IP protection category: IP 67
- Package contains: battery, instruction manual, case

FEATURES 16 EWR-AR

- Digit height: 8.5 mm
- Data interface: USB, Opto RS232C, Digimatic
- Energy supply: Battery life approx. 3 years

ACCESSORIES

Order no.	For measuring instrument	Product name	Type
4102220	16 EWri-AR	Receiver for instruments with integrated wireless	i-Stick
4102357	16 EWR-AR	16 EXu data connection cable USB (2 m)	16 EXu
4102410	16 EWR-AR	Data connection cable RS232C (2 m)	16 EXr
4102520	16 EWR-AR, 16 EWri-AR	Battery 3 V, CR 2032	
4102915	16 EWR-AR	Digimatic data cable (2 m)	16 EWD



i-Stick

MarCal 16 EWRI-NA / 16 EWR-NA

Digital Caliper for Special Applications

FUNCTIONS 16 EWRI-NA

- ON/OFF
- AUTO-ON / OFF
- mm/inch
- LOCK function (key lock)
- RESET (set display to zero)
- PRESET (for entering a numerical value)
- DATA (data transmission)
- HOLD (storage of measured values)

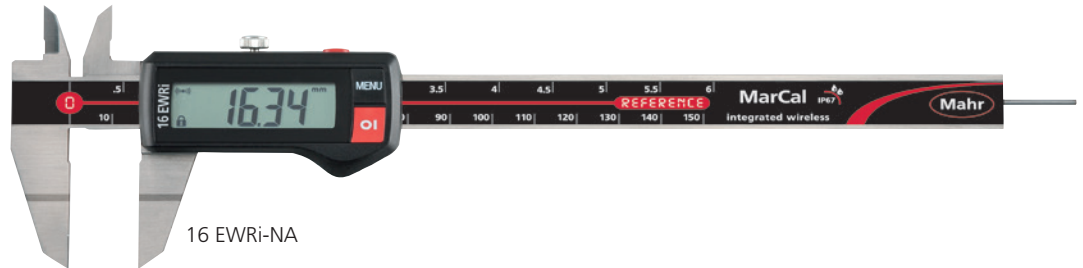

16 EWRI-NA

FUNCTIONS 16 EWR-NA

- ON/OFF
- AUTO-ON / OFF
- mm/inch
- LOCK function (key lock)
- RESET (set display to zero)
- DATA (data transmission via connection cable)



16 EWR-NA

- High contrast analog display
- Locking screw above
- Lapped guideway
- Measuring blade for inside measurements
- Slide and beam made of hardened stainless steel
- Step measuring function
- Immediate measurements due to the Reference System
- Raised guideway for the protection of the scale
- Excellent resistance against dust, coolants and lubricants
- Dirt wipers are integrated in the slide

Application:

For measuring keyseats

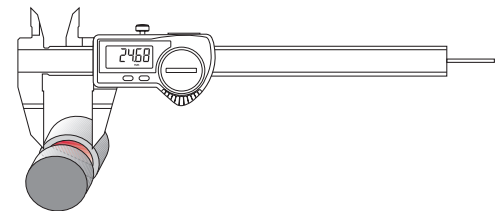

TECHNICAL DATA

Order no.	Type	Measuring range mm	Measuring range inch	Numerical increment mm/inch	Error limit mm	Error limit inches (text)	Standard	Depth rod
4103374	16 EWRI-NA	0-150	0-6"	0.01 / .0005"	0.03	.001"	Factory standard	round
4103074	16 EWR-NA	0-150	0-6"	0.01 / .0005"	0.03	.001"	Factory standard	round

FEATURES 16 EWRI-NA

- Software MarCom Professional free download: www.mahr.com/marcom (only for Mahr data cables and wireless systems with USB and RS232 interface)
- Digit height: 11 mm
- Data interface: Integrated wireless
- Energy supply: Battery life approx. 3 years (approx. 0.5 in wireless mode)
- IP protection category: IP 67
- Package contains: battery, instruction manual, case

Order no.	a	b	c	d	e
4103374	20	40	16.5	235	16
4103074	20	40	16.5	235	16

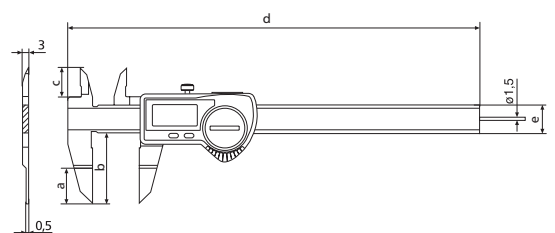

FEATURES 16 EWR-NA

- Digit height: 8.5 mm
- Data interface: USB, Opto RS232C, Digimatic
- Energy supply: Battery life approx. 3 years

ACCESSORIES

Order no.	For measuring instrument	Product name	Type
4102220	16 EWRI-NA	Receiver for instruments with integrated wireless	i-Stick
4102357	16 EWR-NA	16 EXu data connection cable USB (2 m)	16 EXu
4102410	16 EWR-NA	Data connection cable RS232C (2 m)	16 EXr
4102520	16 EWR-NA, 16 EWRI-NA	Battery 3 V, CR 2032	
4102915	16 EWR-NA	Digimatic data cable (2 m)	16 EWd



i-Stick

MarCal 16 EWri-S / 16 EWR-S

Digital Caliper for Special Applications

FUNCTIONS 16 EWri-S

- ON/OFF
- AUTO-ON / OFF
- mm/inch
- LOCK function (key lock)
- RESET (set display to zero)
- PRESET (for entering a numerical value)
- DATA (data transmission)
- HOLD (storage of measured values)



16 EWri-S

FUNCTIONS 16 EWR-S

- ON/OFF
- AUTO-ON / OFF
- mm/inch
- LOCK function (key lock)
- RESET (set display to zero)
- DATA (data transmission via connection cable)
- High contrast analog display
- Locking screw above
- Lapped guideway
- Measuring blade for inside measurements
- Slide and beam made of hardened stainless steel
- Step measuring function
- Immediate measurements due to the Reference System
- Raised guideway for the protection of the scale
- Excellent resistance against dust, coolants and lubricants
- Dirt wipers are integrated in the slide

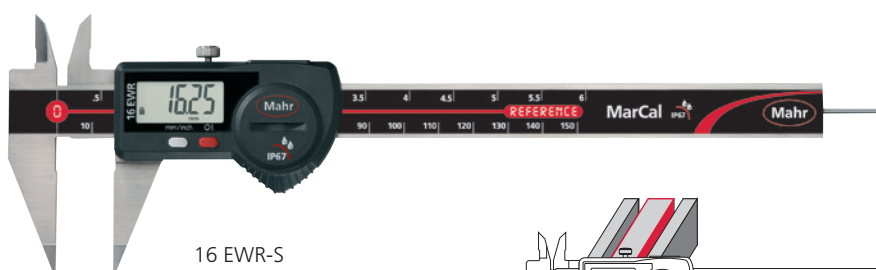

16 EWR-S

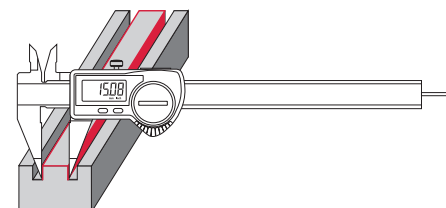

Application:

With pointed jaws e.g. for measuring distances between grooves

TECHNICAL DATA

Order no.	Type	Measuring range	Measuring range inch	Numerical increment	Error limit	Error limit inches (text)	Standard	Depth rod
		mm	inch	mm/inch	mm	inch		
4103375	16 EWri-S	0 – 150	0 – 6"	0.01 / .0005"	0.03	.001"	Factory standard	round
4103075	16 EWR-S	0 – 150	0 – 6"	0.01 / .0005"	0.03	.001"	Factory standard	round

Order no.	a	b	c	d	e
	mm	mm	mm	mm	mm
4103375	10	40	16.5	235	16
4103075	10	40	16.5	235	16

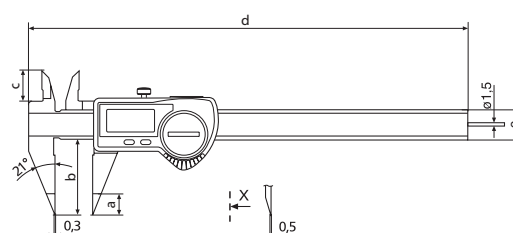

FEATURES 16 EWri-S

- Software MarCom Professional free download: www.mahr.com/marcom (only for Mahr data cables and wireless systems with USB and RS232 interface)
- Digit height: 11 mm
- Data interface: Integrated wireless
- Energy supply: Battery life approx. 3 years (approx. 0.5 in wireless mode)
- IP protection category: IP 67
- Package contains: battery, instruction manual, case

FEATURES 16 EWR-S

- Digit height: 8.5 mm
- Data interface: USB, Opto RS232C, Digimatic
- Energy supply: Battery life approx. 3 years

ACCESSORIES

Order no.	For measuring instrument	Product name	Type
4102220	16 EWri-S	Receiver for instruments with integrated wireless	i-Stick
4102357	16 EWR-S	16 EXu data connection cable USB (2 m)	16 EXu
4102410	16 EWR-S	Data connection cable RS232C (2 m)	16 EXr
4102520	16 EWR-S, 16 EWri-S	Battery 3 V, CR 2032	
4102915	16 EWR-S	Digimatic data cable (2 m)	16 EWd



i-Stick

MarCal 16 EWRI-SM / 16 EWR-SM

Digital Caliper for Special Applications

FUNCTIONS 16 EWRI-SM

- ON/OFF
- AUTO-ON / OFF
- mm/inch
- LOCK function (key lock)
- RESET (set display to zero)
- PRESET (for entering a numerical value)
- DATA (data transmission)
- HOLD (storage of measured values)



16 EWRI-SM



FUNCTIONS 16 EWR-SM

- ON/OFF
- AUTO-ON / OFF
- mm/inch
- LOCK function (key lock)
- RESET (set display to zero)
- DATA (data transmission via connection cable)
- High contrast analog display
- Locking screw above
- Lapped guideway
- Measuring blade for inside measurements
- Slide and beam made of hardened stainless steel
- Step measuring function
- Immediate measurements due to the Reference System
- Raised guideway for the protection of the scale
- Excellent resistance against dust, coolants and lubricants
- Dirt wipers are integrated in the slide

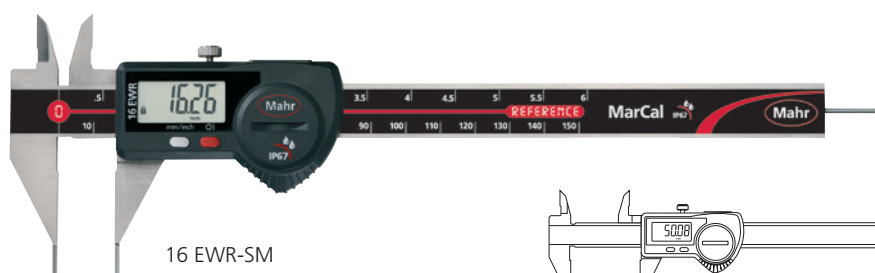

16 EWR-SM



Application:

With pointed jaws e.g. for measuring distances between grooves

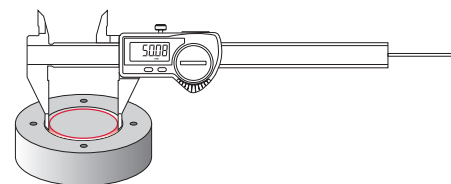

TECHNICAL DATA

Order no.	Type	Measuring range	Measuring range inch	Numerical increment	Error limit	Error limit inches (text)	Standard	Depth rod
		mm	inch	mm/inch	mm	inch		
4103376	16 EWRI-SM	0-150	0-6"	0.01 / .0005"	0.03	.001"	Factory standard	round
4103076	16 EWR-SM	0-150	0-6"	0.01 / .0005"	0.03	.001"	Factory standard	round

Order no.	a	b	c	d	e
	mm	mm	mm	mm	mm
4103376	10	40	16.5	235	16
4103076	10	40	16.5	235	16

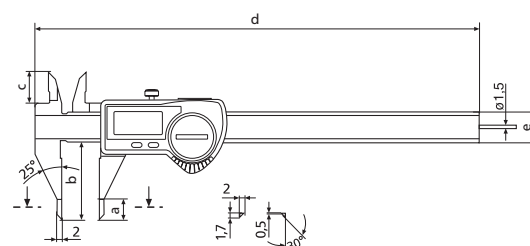

FEATURES 16 EWRI-SM

- SoftwareMarCom Professional free download: www.mahr.com/marcom (only for Mahr data cables and wireless systems with USB and RS232 interface)
- **Digit height:** 11 mm
- **Data interface:** Integrated wireless
- **Energy supply:** Battery life approx. 3 years (approx. 0.5 in wireless mode)
- **IP protection category:** IP 67
- **Package contains:** battery, instruction manual, case

FEATURES 16 EWR-SM

- **Digit height:** 8.5 mm
- **Data interface:** USB, Opto RS232C, Digimatic
- **Energy supply:** Battery life approx. 3 years

ACCESSORIES

Order no.	For measuring instrument	Product name	Type
4102220	16 EWRI-SM	Receiver for instruments with integrated wireless	i-Stick
4102357	16 EWR-SM	16 EXu data connection cable USB (2 m)	16 EXu
4102410	16 EWR-SM	Data connection cable RS232C (2 m)	16 EXr
4102520	16 EWR-SM, 16 EWRI-SM	Battery 3 V, CR 2032	
4102915	16 EWR-SM	Digimatic data cable (2 m)	16 EWd



i-Stick

MarCal 16 EWri-VS / 16 EWR-VS

Digital Caliper for Special Applications

FUNCTIONS 16 EWri-VS

- ON/OFF
- AUTO-ON / OFF
- mm/inch
- LOCK function (key lock)
- RESET (set display to zero)
- PRESET (for entering a numerical value)
- DATA (data transmission)
- HOLD (storage of measured values)



16 EWri-VS

FUNCTIONS 16 EWR-VS

- ON/OFF
- AUTO-ON / OFF
- mm/inch
- LOCK function (key lock)
- RESET (set display to zero)
- DATA (data transmission via connection cable)
- High contrast analog display
- Locking screw above
- Lapped guideway
- Measuring blade for inside measurements
- Slide and beam made of hardened stainless steel
- Immediate measurements due to the Reference System
- Raised guideway for the protection of the scale
- Excellent resistance against dust, coolants and lubricants
- Dirt wipers are integrated in the slide

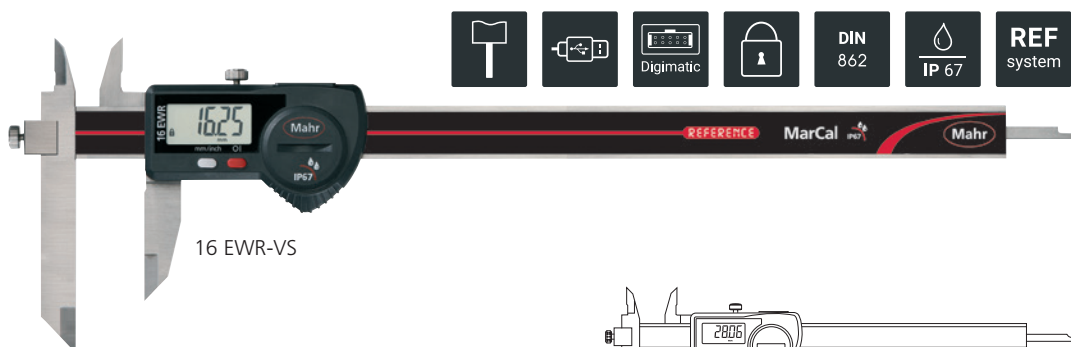

16 EWR-VS

Application:

With moving jaws for measuring stepped workpieces

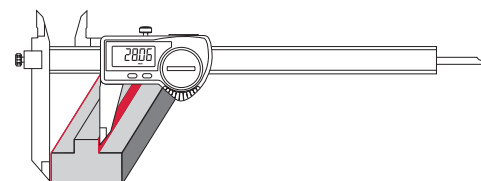

TECHNICAL DATA

Order no.	Type	Measuring range	Measuring range inch	Numerical increment	Error limit	Error limit inches (text)	Standard	Depth rod
4103383	16 EWri-VS	0 –200	0 –8"	0.01 / .0005"	0.04	.0015"	Factory standard	rectangular
4103083	16 EWR-VS	0 –200	0 –8"	0.01 / .0005"	0.04	.0015"	Factory standard	rectangular

Order no.	a	c	d	e
	mm	mm	mm	mm
4103383	14	18	278	16
4103083	14	18	278	16

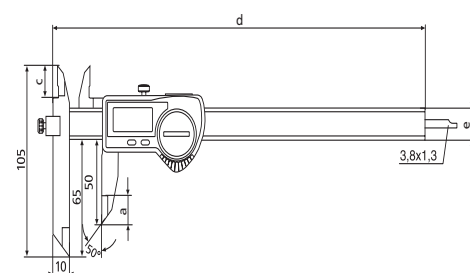

FEATURES 16 EWri-VS

- SoftwareMarCom Professional free download: www.mahr.com/marcom (only for Mahr data cables and wireless systems with USB and RS232 interface)
- **Digit height:** 11 mm
- **Data interface:** Integrated wireless
- **Energy supply:** Battery life approx. 3 years (approx. 0.5 in wireless mode)
- **IP protection category:** IP 67
- **Package contains:** battery, instruction manual, case

FEATURES 16 EWR-VS

- **Digit height:** 8.5 mm
- **Data interface:** USB, Opto RS232C, Digimatic
- **Energy supply:** Battery life approx. 3 years

ACCESSORIES

Order no.	For measuring instrument	Product name	Type
4102220	16 EWri-VS	Receiver for instruments with integrated wireless	i-Stick
4102357	16 EWR-VS	16 EXu data connection cable USB (2 m)	16 EXu
4102410	16 EWR-VS	Data connection cable RS232C (2 m)	16 EXr
4102520	16 EWR-VS, 16 EWri-VS	Battery 3 V, CR 2032	
4102915	16 EWR-VS	Digimatic data cable (2 m)	16 EWd



i-Stick

MarCal 16 EWRI-BA / 16 EWR-BA

Digital Caliper for Special Applications

FUNCTIONS 16 EWRI-BA

- ON/OFF
- AUTO-ON / OFF
- mm/inch
- LOCK function (key lock)
- RESET (set display to zero)
- PRESET (for entering a numerical value)
- DATA (data transmission)
- HOLD (storage of measured values)



16 EWRI-BA

FUNCTIONS 16 EWR-BA

- ON/OFF
- AUTO-ON / OFF
- mm/inch
- LOCK function (key lock)
- RESET (set display to zero)
- PRESET (for entering a numerical value)
- DATA (data transmission via connection cable)
- High contrast analog display
- Locking screw above
- Lapped guideway
- Slide and beam made of hardened stainless steel
- Immediate measurements due to the Reference System
- Raised guideway for the protection of the scale
- Excellent resistance against dust, coolants and lubricants
- Dirt wipers are integrated in the slide

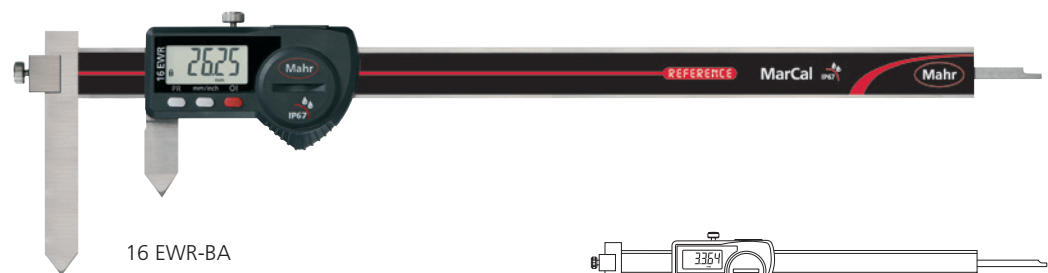

16 EWR-BA

Application:

For measuring the distance between bores

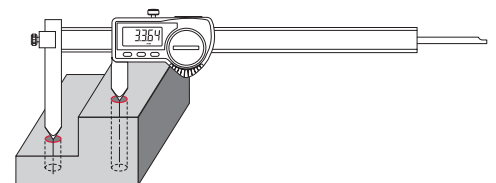

TECHNICAL DATA

Order no.	Type	Measuring range mm	Measuring range inch	Numerical increment mm/inch	Error limit mm	Error limit inches (text)	Standard	Depth rod
4103384	16 EWRI-BA	10 -210	0.4 -8.3"	0.01 / .0005"	0.04	.0015"	Factory standard rectangular	
4103084	16 EWR-BA	10 -210	0.4 -8.3"	0.01 / .0005"	0.04	.0015"	Factory standard rectangular	

Order no.	d	e
	mm	mm
4103384	278	16
4103084	278	16

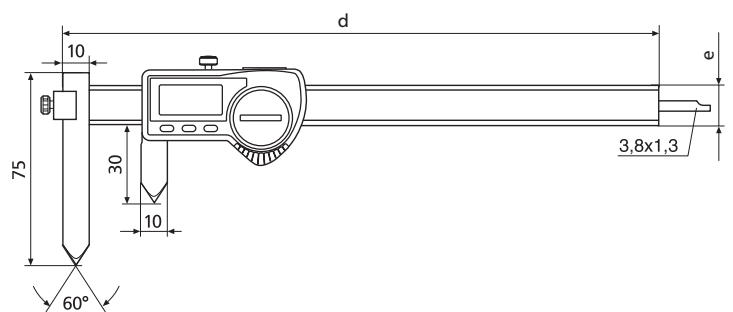

FEATURES 16 EWRI-BA

- Software MarCom Professional free download: www.mahr.com/marcom (only for Mahr data cables and wireless systems with USB and RS232 interface)
- **Digit height:** 11 mm
- **Data interface:** Integrated wireless
- **Energy supply:** Battery life approx. 3 years (approx. 0.5 in wireless mode)
- **IP protection category:** IP 67
- **Package contains:** battery, instruction manual, case

FEATURES 16 EWR-BA

- **Digit height:** 8.5 mm
- **Data interface:** USB, Opto RS232C, Digimatic
- **Energy supply:** Battery life approx. 3 years

ACCESSORIES

Order no.	For measuring instrument	Product name	Type
4102220	16 EWRI-BA	Receiver for instruments with integrated wireless	i-Stick
4102357	16 EWR-BA	16 EXu data connection cable USB (2 m)	16 EXu
4102410	16 EWR-BA	Data connection cable RS232C (2 m)	16 EXr
4102520	16 EWR-BA, 16 EWRI-BA	Battery 3 V, CR 2032	
4102915	16 EWR-BA	Digimatic data cable (2 m)	16 EWd



i-Stick

MarCal 16 EWri-SA / 16 EWR-SA

Digital Caliper for Special Applications

FUNCTIONS 16 EWri-SA

- ON/OFF
- AUTO-ON / OFF
- mm/inch
- LOCK function (key lock)
- RESET (set display to zero)
- PRESET (for entering a numerical value)
- DATA (data transmission)
- HOLD (storage of measured values)



FUNCTIONS 16 EWR-SA

- ON/OFF
- AUTO-ON / OFF
- mm/inch
- LOCK function (key lock)
- RESET (set display to zero)
- DATA (data transmission via connection cable)
- High contrast analog display
- Locking screw above
- Lapped guideway
- Slide and beam made of hardened stainless steel
- Immediate measurements due to the Reference System
- Raised guideway for the protection of the scale
- Excellent resistance against dust, coolants and lubricants
- Dirt wipers are integrated in the slide



Application:

Inward-angled measuring tips for measuring wall thicknesses and recesses on shafts

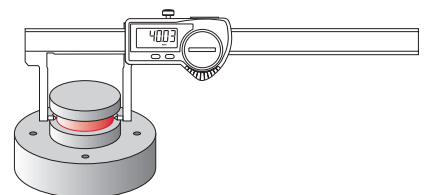

TECHNICAL DATA

FEATURES 16 EWri-SA

- SoftwareMarCom Professional free download: www.mahr.com/marcom (only for Mahr data cables and wireless systems with USB and RS232 interface)
- **Digit height:** 11 mm
- **Data interface:** Integrated wireless
- **Energy supply:** Battery life approx. 3 years (approx. 0.5 in wireless mode)
- **IP protection category:** IP 67
- **Package contains:** battery, instruction manual, case

Order no.	Type	Measuring range	Measuring range inch	Numerical increment	Error limit	Error limit inches (text)	Standard	Depth rod
4103377	16 EWri-SA	0 – 140	0 – 6"	0.01 / .0005"	0.03	.001"	Factory standard	none
4103077	16 EWR-SA	0 – 140	0 – 6"	0.01 / .0005"	0.03	.001"	Factory standard	none

Order no.	b	d	e
	mm	mm	mm
4103377	40	235	16
4103077	40	235	16

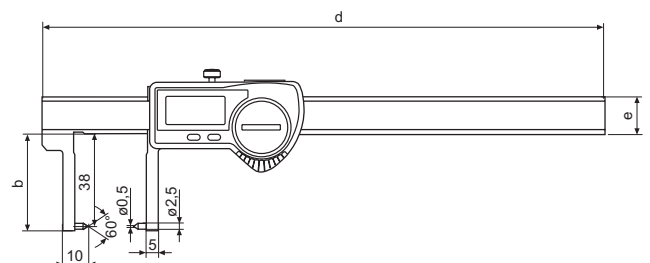

FEATURES 16 EWR-SA

- **Digit height:** 8.5 mm
- **Data interface:** USB, Opto RS232C, Digimatic
- **Energy supply:** Battery life approx. 3 years

ACCESSORIES

Order no.	For measuring instrument	Product name	Type
4102220	16 EWri-SA	Receiver for instruments with integrated wireless	i-Stick
4102357	16 EWR-SA	16 EXu data connection cable USB (2 m)	16 EXu
4102410	16 EWR-SA	Data connection cable RS232C (2 m)	16 EXr
4102520	16 EWR-SA, 16 EWri-SA	Battery 3 V, CR 2032	
4102915	16 EWR-SA	Digimatic data cable (2 m)	16 EWd



i-Stick

MarCal 16 EWri-AA / 16 EWR-AA

Digital Caliper for Special Applications

FUNCTIONS 16 EWri-AA

- ON/OFF
- AUTO-ON / OFF
- mm/inch
- LOCK function (key lock)
- RESET (set display to zero)
- PRESET (for entering a numerical value)
- DATA (data transmission)
- HOLD (storage of measured values)



16 EWri-AA

FUNCTIONS 16 EWR-AA

- ON/OFF
- AUTO-ON / OFF
- mm/inch
- LOCK function (key lock)
- RESET (set display to zero)
- DATA (data transmission via connection cable)
- High contrast analog display
- Locking screw above
- Lapped guideway
- Slide and beam made of hardened stainless steel
- Immediate measurements due to the Reference System
- Raised guideway for the protection of the scale
- Excellent resistance against dust, coolants and lubricants
- Dirt wipers are integrated in the slide



16 EWR-AA

Application:

Inward-angled measuring surfaces for measuring wall thicknesses and recesses on shafts

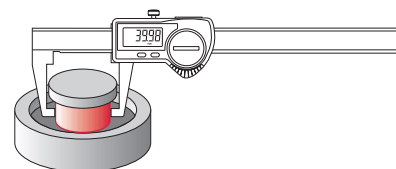

TECHNICAL DATA

Order no.	Type	Measuring range mm	Measuring range inch	Numerical increment mm/inch	Error limit mm	Error limit inches (text)	Standard	Depth rod
4103379	16 EWri-AA	0 - 150	0 - 6"	0.01 / .0005"	0.03	.001"	Factory standard	none
4103079	16 EWR-AA	0 - 150	0 - 6"	0.01 / .0005"	0.03	.001"	Factory standard	none

Order no.	b	d	e
4103379	40	235	16
4103079	40	235	16

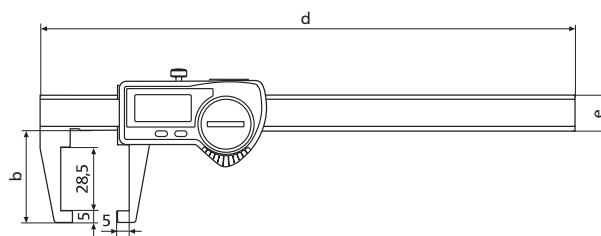

FEATURES 16 EWri-AA

- SoftwareMarCom Professional free download: www.mahr.com/marcom (only for Mahr data cables and wireless systems with USB and RS232 interface)
- **Digit height:** 11 mm
- **Data interface:** Integrated wireless
- **Energy supply:** Battery life approx. 3 years (approx. 0.5 in wireless mode)
- **IP protection category:** IP 67
- **Package contains:** battery, instruction manual, case

FEATURES 16 EWR-AA

- **Digit height:** 8.5 mm
- **Data interface:** USB, Opto RS232C, Digimatic
- **Energy supply:** Battery life approx. 3 years

ACCESSORIES

Order no.	For measuring instrument	Product name	Type
4102220	16 EWri-AA	Receiver for instruments with integrated wireless	i-Stick
4102357	16 EWR-AA	16 EXu data connection cable USB (2 m)	16 EXu
4102410	16 EWR-AA	Data connection cable RS232C (2 m)	16 EXr
4102520	16 EWR-AA, 16 EWri-AA	Battery 3 V, CR 2032	
4102915	16 EWR-AA	Digimatic data cable (2 m)	16 EWd



i-Stick

MarCal 16 EWri-SI / 16 EWR-SI

Digital Caliper for Special Applications

FUNCTIONS 16 EWri-SI

- ON/OFF
- AUTO-ON / OFF
- mm/inch
- LOCK function (key lock)
- RESET (set display to zero)
- PRESET (for entering a numerical value)
- DATA (data transmission)
- HOLD (storage of measured values)



FUNCTIONS 16 EWR-SI

- ON/OFF
- AUTO-ON / OFF
- mm/inch
- LOCK function (key lock)
- RESET (set display to zero)
- PRESET (for entering a numerical value)
- DATA (data transmission via connection cable)
- High contrast analog display
- Locking screw above
- Lapped guideway
- Slide and beam made of hardened stainless steel
- Immediate measurements due to the Reference System
- Raised guideway for the protection of the scale
- Excellent resistance against dust, coolants and lubricants
- Dirt wipers are integrated in the slide



Application:

Outward-angled measuring tips for measuring recesses in bores

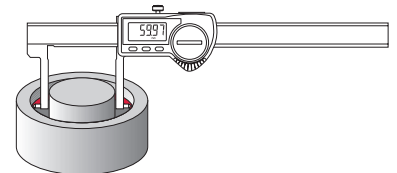

TECHNICAL DATA

Order no.	Type	Measuring range		Numerical increment	Error limit		Standard	Depth rod
		mm	inch		mm	inch		
4103378	16 EWri-SI	20 - 170	0.8 - 6.7"	0.01 / .0005"	0.03	.001"	Factory standard	none
4103078	16 EWR-SI	20 - 170	0.8 - 6.7"	0.01 / .0005"	0.03	.001"	Factory standard	none

FEATURES 16 EWri-SI

- SoftwareMarCom Professional free download: www.mahr.com/marcom (only for Mahr data cables and wireless systems with USB and RS232 interface)
- **Digit height:** 11 mm
- **Data interface:** Integrated wireless
- **Energy supply:** Battery life approx. 3 years (approx. 0.5 in wireless mode)
- **IP protection category:** IP 67
- **Package contains:** battery, instruction manual, case

Order no.	b	d	e
	mm	mm	mm
4103378	28	235	16
4103078	28	235	16

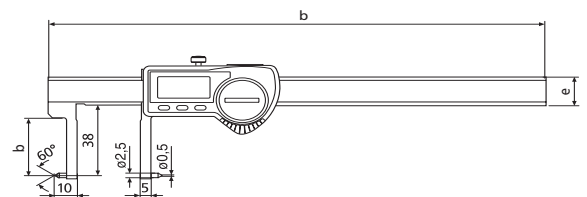

FEATURES 16 EWR-SI

- **Digit height:** 8.5 mm
- **Data interface:** USB, Opto RS232C, Digimatic
- **Energy supply:** Battery life approx. 3 years

ACCESSORIES

Order no.	For measuring instrument	Product name	Type
4102220	16 EWri-SI	Receiver for instruments with integrated wireless	i-Stick
4102357	16 EWR-SI	16 EXu data connection cable USB (2 m)	16 EXu
4102410	16 EWR-SI	Data connection cable RS232C (2 m)	16 EXr
4102520	16 EWR-SI, 16 EWri-SI	Battery 3 V, CR 2032	
4102915	16 EWR-SI	Digimatic data cable (2 m)	16 EWd



i-Stick

MarCal 16 EWRI-AI / 16 EWR-AI

Digital Caliper for Special Applications

FUNCTIONS 16 EWRI-AI

- ON/OFF
- AUTO-ON / OFF
- mm/inch
- LOCK function (key lock)
- RESET (set display to zero)
- PRESET (for entering a numerical value)
- DATA (data transmission)
- HOLD (storage of measured values)



16 EWRI-AI

FUNCTIONS 16 EWR-AI

- ON/OFF
- AUTO-ON / OFF
- mm/inch
- LOCK function (key lock)
- RESET (set display to zero)
- PRESET (for entering a numerical value)
- DATA (data transmission via connection cable)
- High contrast analog display
- Locking screw above
- Lapped guideway
- Slide and beam made of hardened stainless steel
- Immediate measurements due to the Reference System
- Raised guideway for the protection of the scale
- Excellent resistance against dust, coolants and lubricants
- Dirt wipers are integrated in the slide



16 EWR-AI

Application:

Outward-angled measuring surfaces for measuring recesses in bores

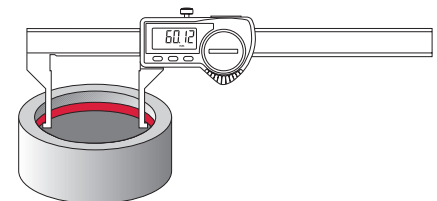

TECHNICAL DATA

Order no.	Type	Measuring range		Numerical increment	Error limit		Standard	Depth rod
		mm	inch		mm	inches (text)		
4103380	16 EWRI-AI	10 - 160	0.4 - 6.3"	0.01 / .0005"	0.03	.001"	Factory standard	none
4103080	16 EWR-AI	10 - 160	0.4 - 6.3"	0.01 / .0005"	0.03	.001"	Factory standard	none

Order no.	b	d	e
	mm	mm	mm
4103380	40	235	16
4103080	40	235	16

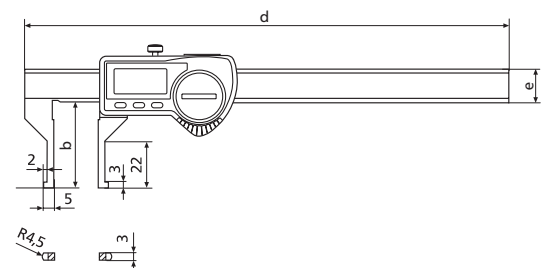

FEATURES 16 EWRI-AI

- Software MarCom Professional free download: www.mahr.com/marcom (only for Mahr data cables and wireless systems with USB and RS232 interface)
- **Digit height:** 11 mm
- **Data interface:** Integrated wireless
- **Energy supply:** Battery life approx. 3 years (approx. 0.5 in wireless mode)
- **IP protection category:** IP 67
- **Package contains:** battery, instruction manual, case

FEATURES 16 EWR-AI

- **Digit height:** 8.5 mm
- **Data interface:** USB, Opto RS232C, Digimatic
- **Energy supply:** Battery life approx. 3 years

ACCESSORIES

Order no.	For measuring instrument	Product name	Type
4102220	16 EWRI-AI	Receiver for instruments with integrated wireless	i-Stick
4102357	16 EWR-AI	16 EXu data connection cable USB (2 m)	16 EXu
4102410	16 EWR-AI	Data connection cable RS232C (2 m)	16 EXr
4102520	16 EWR-AI, 16 EWRI-AI	Battery 3 V, CR 2032	
4102915	16 EWR-AI	Digimatic data cable (2 m)	16 EWd



i-Stick

MarCal 16 EWri-RW / 16 EWR-RW

Digital Caliper for Special Applications

FUNCTIONS 16 EWri-RW

- ON/OFF
- AUTO-ON / OFF
- mm/inch
- LOCK function (key lock)
- RESET (set display to zero)
- PRESET (for entering a numerical value)
- DATA (data transmission)
- HOLD (storage of measured values)



16 EWri-RW



FUNCTIONS 16 EWR-RW

- ON/OFF
- AUTO-ON / OFF
- mm/inch
- LOCK function (key lock)
- RESET (set display to zero)
- DATA (data transmission via connection cable)
- High contrast analog display
- Locking screw above
- Lapped guideway
- Slide and beam made of hardened stainless steel
- Immediate measurements due to the Reference System
- Raised guideway for the protection of the scale
- Excellent resistance against dust, coolants and lubricants
- Dirt wipers are integrated in the slide



16 EWR-RW



Application:

Measurement of wall thicknesses

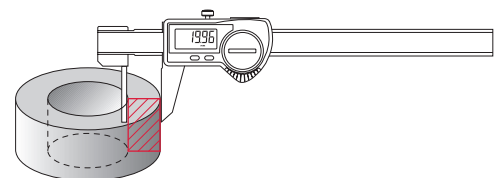

TECHNICAL DATA

Order no.	Type	Measuring range		Numerical increment	Error limit		Standard	Depth rod
		mm	inch		mm	inches (text)		
4103381	16 EWri-RW	0 - 150	0 - 6"	0.01 / .0005"	0.05	.002"	Factory standard	none
4103081	16 EWR-RW	0 - 150	0 - 6"	0.01 / .0005"	0.05	.002"	Factory standard	none

Order no.	b	d	e
	mm	mm	mm
4103381	40	235	16
4103081	40	235	16

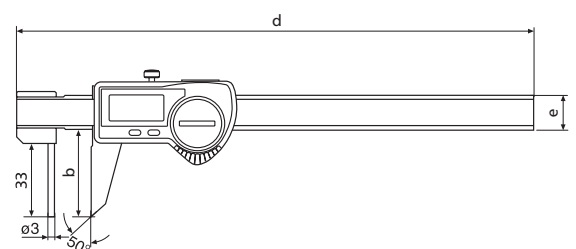

FEATURES 16 EWri-RW

- SoftwareMarCom Professional free download: www.mahr.com/marcom (only for Mahr data cables and wireless systems with USB and RS232 interface)
- **Digit height:** 11 mm
- **Data interface:** Integrated wireless
- **Energy supply:** Battery life approx. 3 years (approx. 0.5 in wireless mode)
- **IP protection category:** IP 67
- **Package contains:** battery, instruction manual, case

FEATURES 16 EWR-RW

- **Digit height:** 8.5 mm
- **Data interface:** USB, Opto RS232C, Digimatic
- **Energy supply:** Battery life approx. 3 years

ACCESSORIES

Order no.	For measuring instrument	Product name	Type
4102220	16 EWri-RW	Receiver for instruments with integrated wireless	i-Stick
4102357	16 EWR-RW	16 EXu data connection cable USB (2 m)	16 EXu
4102410	16 EWR-RW	Data connection cable RS232C (2 m)	16 EXr
4102520	16 EWR-RW, 16 EWri-RW	Battery 3 V, CR 2032	
4102915	16 EWR-RW	Digimatic data cable (2 m)	16 EWd



i-Stick

MarCal 16 EWri-LI / 16 EWR-LI

Digital Caliper for Special Applications

FUNCTIONS 16 EWri-LI

- ON/OFF
- AUTO-ON / OFF
- mm/inch
- LOCK function (key lock)
- RESET (set display to zero)
- PRESET (for entering a numerical value)
- DATA (data transmission)
- HOLD (storage of measured values)



16 EWri-LI

FUNCTIONS 16 EWR-LI

- ON/OFF
- AUTO-ON / OFF
- mm/inch
- LOCK function (key lock)
- RESET (set display to zero)
- PRESET (for entering a numerical value)
- DATA (data transmission via connection cable)
- High contrast analog display
- Locking screw above
- Lapped guideway
- Measuring blade for inside measurements
- Slide and beam made of hardened stainless steel
- Immediate measurements due to the Reference System
- Raised guideway for the protection of the scale
- Excellent resistance against dust, coolants and lubricants
- Dirt wipers are integrated in the slide



16 EWR-LI

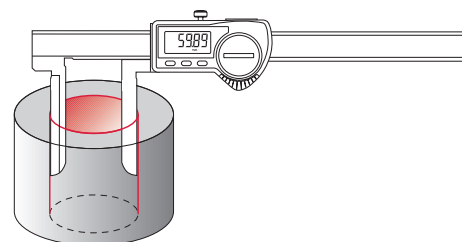

Application:

With long inner blades

TECHNICAL DATA

Order no.	Type	Measuring range		Numerical increment	Error limit		Standard	Depth rod
		mm	inch		mm	inches (text)		
4103385	16 EWri-LI	10 - 200	0.4 - 8"	0.01 / .0005"	0.05	.002"	Factory standard	none
4103085	16 EWR-LI	10 - 200	0.4 - 8"	0.01 / .0005"	0.05	.002"	Factory standard	none

FEATURES 16 EWri-LI

- Software MarCom Professional free download: www.mahr.com/marcom (only for Mahr data cables and wireless systems with USB and RS232 interface)
- **Digit height:** 11 mm
- **Data interface:** Integrated wireless
- **Energy supply:** Battery life approx. 3 years (approx. 0.5 in wireless mode)
- **IP protection category:** IP 67
- **Package contains:** battery, instruction manual, case

Order no.	b	d	e
	mm	mm	mm
4103385	60	285	16
4103085	60	285	16

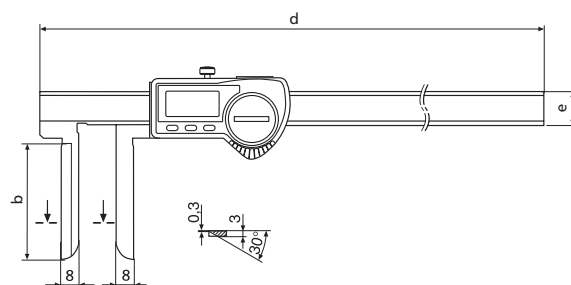

FEATURES 16 EWR-LI

- **Digit height:** 8.5 mm
- **Data interface:** USB, Opto RS232C, Digimatic
- **Energy supply:** Battery life approx. 3 years

ACCESSORIES

Order no.	For measuring instrument	Product name	Type
4102220	16 EWri-LI	Receiver for instruments with integrated wireless	i-Stick
4102357	16 EWR-LI	16 EXu data connection cable USB (2 m)	16 EXu
4102410	16 EWR-LI	Data connection cable RS232C (2 m)	16 EXr
4102520	16 EWR-LI, 16 EWri-LI	Battery 3 V, CR 2032	
4102915	16 EWR-LI	Digimatic data cable (2 m)	16 EWd



i-Stick

MarCal 18 EWR

Digital Workshop Caliper

FUNCTIONS 18 EWR

- AUTO-ON / OFF
- DATA (data transmission via connection cable)
- ON/OFF
- PRESET (for entering a numerical value)
- RESET (set display to zero)
- mm/inch
- LOCK function (key lock)
- High contrast analog display
- Locking screw above
- Rounded measuring blades for inside measurements
- Slide and beam made of hardened stainless steel
- Immediate measurements due to the Reference System
- Raised guideway for the protection of the scale
- Excellent resistance against dust, coolants and lubricants
- Dirt wipers are integrated in the slide



18 EWR, 300 mm with measuring blades

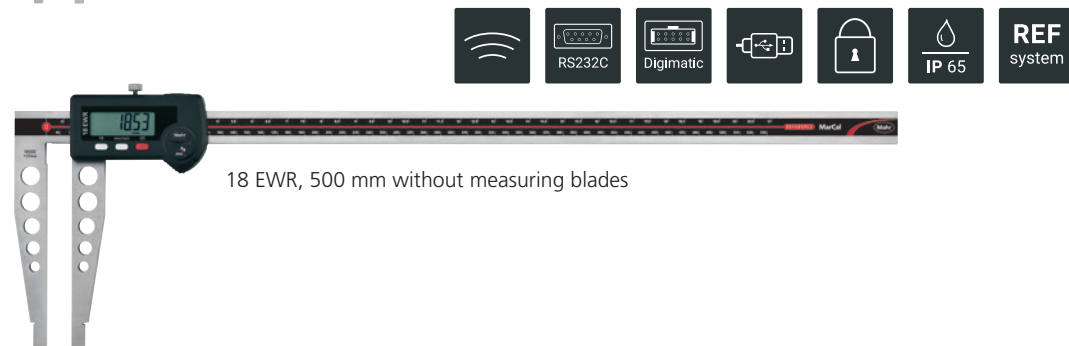

18 EWR, 500 mm without measuring blades

TECHNICAL DATA

Order no.	Type	Measuring range	Measuring range inch	Numerical increment	Measuring blades for outside measurements	Error limit	Error limit inches (text)	Standard	Weight
		mm	inch	mm/inch		mm	inch		kg
4112704	18 EWR	0-300	0-12"	0.01 / .0005"	•	0.03	.001"	Factory standard	0.45
4112712	18 EWR	0-500	0-20"	0.01 / .0005"	•	0.04	.0015"	Factory standard	1.10
4112714	18 EWR	0-750	0-30"	0.01 / .0005"	•	0.05	.002"	Factory standard	1.35
4112716	18 EWR	0-1000	0-40"	0.01 / .0005"	•	0.06	.0025"	Factory standard	2.20
4112705	18 EWR	0-300	0-12"	0.01 / .0005"		0.03	.001"	Factory standard	0.44
4112713	18 EWR	0-500	0-20"	0.01 / .0005"		0.04	.0015"	Factory standard	1.00
4112715	18 EWR	0-750	0-30"	0.01 / .0005"		0.05	.002"	Factory standard	1.28
4112717	18 EWR	0-1000	0-40"	0.01 / .0005"		0.06	.0025"	Factory standard	2.10

Order no.	a	b	c	d	e	f
	mm	mm	mm	mm	mm	mm
4112704	410	90	10	10	20	40
4112712	650	150	20	20	25	55
4112714	905	150	20	20	25	55
4112716	1165	150	20	20	30	60
4112705	410	90	10	10	20	
4112713	650	150	20	20	25	
4112715	905	150	20	20	25	
4112717	1165	150	20	20	30	

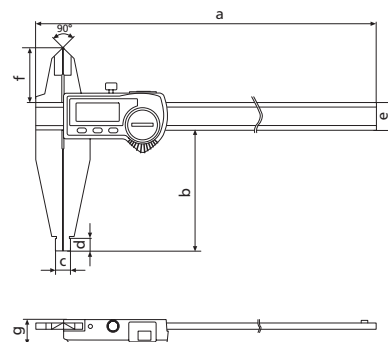

ACCESSORIES

Order no.	For measuring instrument	Product name	Type
4102230	18 EWR	Receiver	e-Stick
4102231	18 EWR	Transmitter for e-Stick	16 EWe
4102357	18 EWR	16 EXu data connection cable USB (2 m)	16 EXu
4102410	18 EWR	Data connection cable RS232C (2 m)	16 EXr
4102520	18 EWR	Battery 3 V, CR 2032	
4102915	18 EWR	Digimatic data cable (2 m)	16 EWd



16 EWe



e-Stick

MarCal 18 ESA

Digital Workshop Caliper

REF system

FUNCTIONS

- ON/OFF
- RESET (set display to zero)
- mm/inch
- HOLD (storage of measured values)
- PRESET (enter a numerical value from range 500 mm)



FEATURES

- High contrast analog display
- Locking screw above
- Rounded measuring blades for inside measurements
- Prisma guideway for a more smooth and even movement
- Measuring surfaces made of steel
- Measuring blades for outside measurements
- To reduce the overall weight the slide and beam are made from aluminum and are coated with a hard anodized surface coating (1100 HV)
- Dirt wipers are integrated in the slide
- **Digit height:** 6 mm (300mm), 10,5 mm
- **Data interface:** Opto RS232C (only 300 mm version)
- **Energy supply:** Battery life approx. 2 years
- **IP protection category:** None
- **Package contains:** battery, instruction manual, case

TECHNICAL DATA

Order no.	Type	Measuring range	Measuring range inch	Numerical increment	Measuring blades for outside measurements	Error limit mm	Error limit inches (text)	Standard	Weight
4112620	18 ESA	0 – 300	0 – 12"	0.01 / .0005"	•	0.04	.0015"	Factory standard	0.50
4112621	18 ESA	0 – 500	0 – 20"	0.01 / .0005"	•	0.05	.002"	Factory standard	1.40
4112622	18 ESA	0 – 800	0 – 32"	0.01 / .0005"	•	0.07	.0025"	Factory standard	1.60
4112623	18 ESA	0 – 1000	0 – 40"	0.01 / .0005"	•	0.08	.003"	Factory standard	1.80

Order no.	a	b	c	d	e	f	g	h	i
	mm	mm	mm	mm	mm	mm	mm	mm	mm
4112620	450	33	90	17.5	10	10	25	4.5	17
4112621	726	42	150	20.7	15	20	31.9	6	29
4112622	1026	42	150	20.7	15	20	31.9	6	29
4112623	1225	42	150	20.7	15	20	31.9	6	29

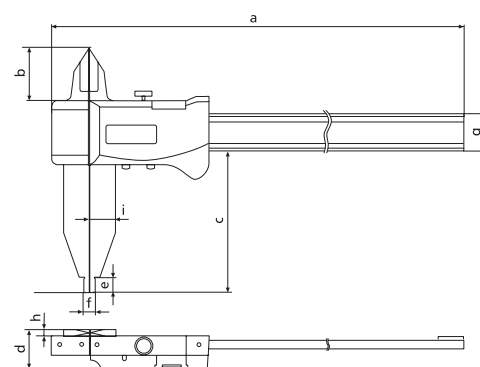

ACCESSORIES

Order no.	Product name	Type
4102330	Opto USB Adapter cable RS232-USB (0.2 m)	Opto USB
4102510	Data connection cable RS232C (2 m)	16 ESv
4102520	Battery 3 V, CR 2032	

MarCal 18 NA

Workshop Calipers

FEATURES

- To reduce the overall weight the slide and beam are made from aluminum and are coated with a hard anodized surface coating (1100 HV)
- Vernier and scale have a satin chrome finish for glare free reading
- Parallax free reading
- Locking screw above
- Prisma guideway for a more smooth and even movement
- Measuring surfaces made of steel
- Measuring blades for outside measurements
- **Package contains:** up to 1000 mm delivered with a case, over 1000 mm individually packed



TECHNICAL DATA

Order no.	Type	Measuring range	Vernier value	Measuring blades for outside measurements	Error limit	Standard	Weight
		mm	mm		mm		kg
4112300	18 NA	0 – 300	0.02	•	0.04	Factory standard	0.50
4112301	18 NA	0 – 500	0.02	•	0.05	Factory standard	1.40
4112302	18 NA	0 – 800	0.02	•	0.07	Factory standard	1.60
4112303	18 NA	0 – 1000	0.02	•	0.08	Factory standard	1.75
4112304	18 NA	0 – 1500	0.02	•	0.16	Factory standard	2.10
4112305	18 NA	0 – 2000	0.02	•	0.16	Factory standard	2.50

Order no.	a	b	c	d	e	f	g	h	i
	mm	mm	mm	mm	mm	mm	mm	mm	mm
4112300	450	33	90	17.5	10	10	25	4.5	17
4112301	726	42	150	20.7	15	20	31.9	6	29
4112302	1026	42	150	20.7	15	20	31.9	6	29
4112303	1226	42	150	20.7	15	20	31.9	6	29
4112304	1760	85	200	25	15	30	48.1	6	40
4112305	2260	85	200	25	15	30	48.1	6	40

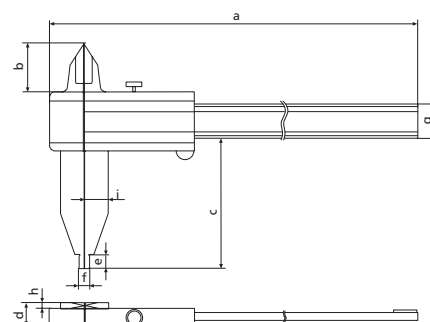

MarCal 18 N

Workshop Calipers

DIN 862

FEATURES

- Vernier and scale have a satin chrome finish for glare free reading
- Locking screw above
- Rounded measuring blades for inside measurements
- Measuring surfaces made of steel
- Slide and beam made of hardened stainless steel
- Raised guideway for the protection of the scale
- **Package contains:** up to 1000 mm delivered with a case, over 1000 mm individually packed

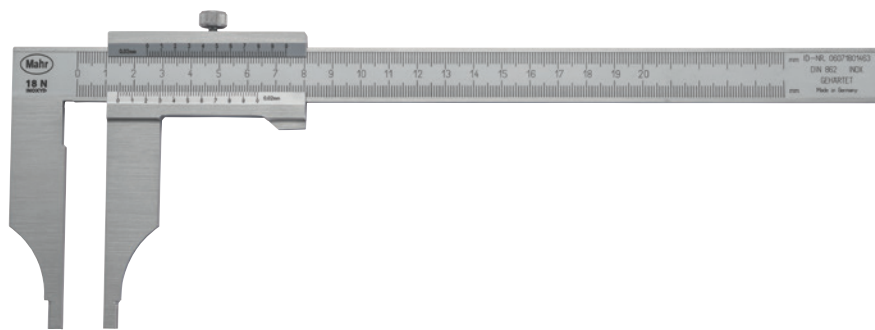

Application:

With two mm scales and vernier scales to directly read external and internal dimensions

- Lower scale for external dimensions
- Upper scale for internal dimensions

TECHNICAL DATA

Order no.	Type	Measuring range	Vernier value	Error limit	Standard
		mm	mm	mm	
4112200	18 N	0 – 200	0.02	0.05	Factory standard
4112201	18 N	0 – 300	0.02	0.05	Factory standard
4112210	18 N	0 – 500	0.05	0.07	DIN 862
4112211	18 N	0 – 800	0.05	0.1	DIN 862
4112212	18 N	0 – 1000	0.05	0.12	DIN 862
4112213	18 N	0 – 1500	0.05	0.18	DIN 862
4112214	18 N	0 – 2000	0.05	0.22	DIN 862

Order no.	a	b	c	e	f
	mm	mm	mm	mm	mm
4112200	5	10	80	310	20
4112201	5	10	90	410	20
4112210	10	19	150	675	25
4112211	10	19	150	985	30
4112212	10	19	150	1185	30
4112213	15	19	200	1760	40
4112214	15	19	200	2270	45

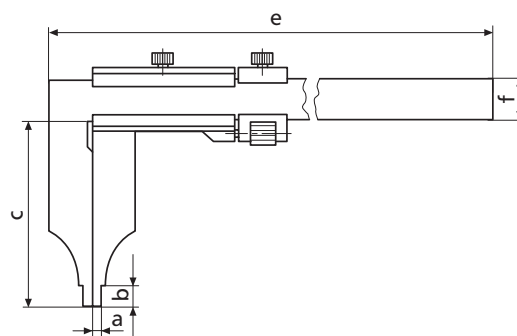

MarCal 18 DN

Workshop Calipers

DIN 862

FEATURES

- Vernier and scale have a satin chrome finish for glare free reading
- Locking screw above
- Rounded measuring blades for inside measurements
- Measuring surfaces made of steel
- Slide and beam made of hardened stainless steel
- Raised guideway for the protection of the scale
- **Package contains:** up to 1000 mm delivered with a case, over 1000 mm individually packed

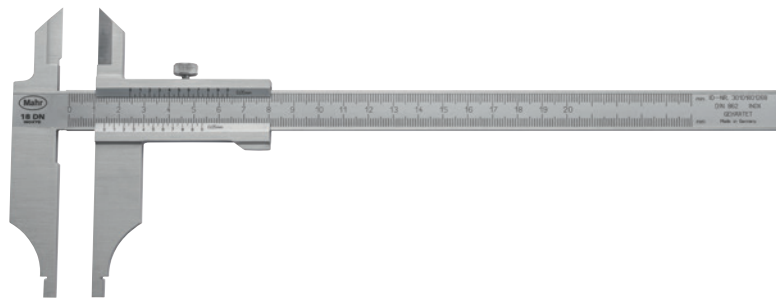

Application:

With two mm scales and vernier scales to directly read external and internal dimensions

- Lower scale for external dimensions
- Upper scale for internal dimensions

TECHNICAL DATA

Order no.	Type	Measuring range	Vernier value	Measuring blades for outside measurements	Error limit	Standard
		mm	mm		mm	
4113200	18 DN	0 – 200	0.05	•	0.05	DIN 862
4113201	18 DN	0 – 300	0.05	•	0.05	DIN 862
4113202	18 DN	0 – 500	0.05	•	0.07	DIN 862
4113203	18 DN	0 – 800	0.05	•	0.1	DIN 862
4113204	18 DN	0 – 1000	0.05	•	0.12	DIN 862
4113205	18 DN	0 – 1500	0.05	•	0.18	DIN 862
4113206	18 DN	0 – 2000	0.05	•	0.22	DIN 862

Order no.	a	b	c	d	e	f
	mm	mm	mm	mm	mm	mm
4113200	5	10	80	40	310	20
4113201	5	10	90	40	410	20
4113202	10	19	150	60	675	25
4113203	10	19	150	65	985	30
4113204	10	19	150	67	1185	30
4113205	15	19	200	86	1760	40
4113206	25	19	200	96	2270	45

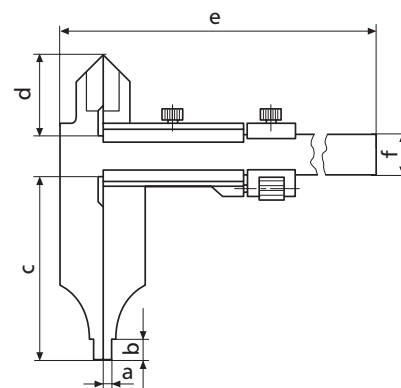

MarCal 18 EWRI

Digital workshop caliper



FUNCTIONS

- ON/OFF
- AUTO-ON / OFF
- HOLD (storage of measured values)
- RESET (set display to zero)
- PRESET (for entering a numerical value)
- Reversal of counting direction
- mm/inch
- LOCK function (key lock)
- DATA (data transmission)



FEATURES

- High contrast analog display
- Locking screw above
- Rounded measuring blades for inside measurements
- Slide and beam made of hardened stainless steel
- Immediate measurements due to the Reference System
- Raised guideway for the protection of the scale
- Excellent resistance against dust, coolants and lubricants
- Dirt wipers are integrated in the slide
- **Software:** MarCom Professional free download: www.mahr.com/marcom (only for Mahr data cables and wireless systems with USB and RS-232 interface)
- **Digit height:** 12,5 mm
- **Data interface:** Integrated wireless
- **Energy supply:** Battery life approx. 3 years (approx. 0.5 in wireless mode)
- **Battery type:** CR 2032 (3V Lithium)
- **IP protection category:** IP 65
- **Package contains:** battery, instruction manual, case

TECHNICAL DATA

Order no.	Type	Measuring range	Resolution	Measuring blades for outside measurements	Error limit	Standard
		mm	mm/inch		mm	
4112571	18 EWRI	0 – 300	0,01 / .0005"	•	0,03	Factory standard
4112572	18 EWRI	0 – 500	0,01 / .0005"	•	0,04	Factory standard
4112573	18 EWRI	0 – 750	0,01 / .0005"	•	0,05	Factory standard
4112574	18 EWRI	0 – 1000	0,01 / .0005"	•	0,06	Factory standard

Order no.	a	b	c	d	e	f
	mm	mm	mm	mm	mm	mm
4112571	430	90	10	10	20	40
4112572	650	150	20	20	25	55
4112573	905	150	20	20	25	55
4112574	1165	150	20	20	30	60

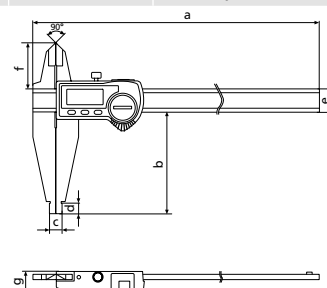

ACCESSORIES

Order no.	Description	Type
4102220	Receiver for instruments with Integrated Wireless	i-Stick



i-Stick